

PHONE: 305-392.9974  
www.fortpro.com



HEAVY DUTY TRUCK & TRAILER PARTS

# HEAVY DUTY PARTS CATALOG



**Air Brake Components**

**Drive Line & Wheel Components**

**Suspension Components**

**Water Pumps & Miscellaneous Components**

**Clutch Components**





## BRIEF INTRODUCTION

FortProUSA is a leader in the research, design and distribution of a broad range of truck parts such as air brake, electrical, driveline, suspension, engine and clutches.

FortProUSA delivers its products and services to customers worldwide through an extensive dealer network.

FortProUSA sells products in more than 25 countries and is expanding its dealer network in Middle East, South America and throughout the world.

FortProUSA is headquartered in Miami, Florida, USA. The Company is strategically located to support its distributors.

Formed in 2005 FortProUSA is a new brand, committed to the long term success of its distributors, offering top quality products, exceptional customer service and competitive prices.



While every effort is made to provide accurate information, no guarantee is provided as to the accuracy on the information contained herein. We are not responsible for any picture and typographical errors. FortProUSA is a registered trademark of World Truck Parts, LLC.





## INDEX

<b>AIR BRAKE COMPONENTS</b>	<b>6</b>
<b>SPRING BRAKE ASSEMBLIES.....</b>	<b>06</b>
<b>SLACKADJUSTERS.....</b>	<b>07</b>
<b>LINED BRAKE SHOES.....</b>	<b>10</b>
<b>UNLINED BRAKE SHOES.....</b>	<b>12</b>
<b>BRAKE SHOE BOX KIT.....</b>	<b>15</b>
<b>BRAKE LINING SETS.....</b>	<b>16</b>
<b>BRAKE DRUMS.....</b>	<b>17</b>
<b>HUBS.....</b>	<b>18</b>
<b>BRAKE REPAIR KITS.....</b>	<b>19</b>
<b>BRAKE SHOE SPRINGS.....</b>	<b>21</b>
<b>BRAKESHOE COMPONENTS.....</b>	<b>23</b>
<b>CAMSHAFT REPAIR KITS.....</b>	<b>25</b>
<b>AIR DRYERS.....</b>	<b>26</b>
<b>AIR VALVES.....</b>	<b>30</b>
<b>MV-3 VALVES.....</b>	<b>51</b>
<b>LEVELING VALVES.....</b>	<b>51</b>
<b>AIR SOLENOID VALVE.....</b>	<b>57</b>
<b>TRANSMISSION SELECTOR VALVE.....</b>	<b>59</b>
<b>AIR HOSE SET.....</b>	<b>65</b>
<b>AIR BRAKE HOSE ASSEMBLY.....</b>	<b>67</b>
<b>NYLON TUBING.....</b>	<b>67</b>
<b>TUBINGCONNECTORS.....</b>	<b>68</b>
<b>AIRCOMPRESSORS.....</b>	<b>71</b>
<b>COMPRESSOR COMPONENTS.....</b>	<b>72</b>





# INDEX

## DRIVE LINE & WHEEL COMPONENTS 76

- UNIVERSAL JOINTS..... 76
- CENTER SUPPORT BEARINGS..... 81
- BEARINGS..... 82
- OIL SEALS..... 83
- HUBCAPS..... 85
- WHEEL CLAMPS..... 89
- WHEEL NUTS..... 90
- WHEEL STUDS..... 91
- WHEEL SLEEVE NUT..... 92
- ALUMINUM& STEEL WHEELS..... 93
- LANDING GEAR &5TH WHEELS..... 94
- KING PIN KITS..... 96
- TIE RODS..... 97
- POWER STEERING PUMPS..... 98

## SUSPENSION COMPONENTS 103

- AIR SPRINGS..... 103
- SHOCK ABSORBERS..... 105
- TRAILER SPRINGS..... 106
- TRUCK SPRINGS..... 107
- HENDRICKSON..... 108
- FREIGHTLINER..... 116
- KENWORTH..... 127
- PETERBILT..... 136
- INTERNATIONAL..... 138





## INDEX

<b>DETROIT.....</b>	<b>145</b>
<b>FORD.....</b>	<b>146</b>
<b>MACK.....</b>	<b>147</b>
<b>VOLVO.....</b>	<b>159</b>
<b>HUTCH.....</b>	<b>162</b>
<b>REYCO.....</b>	<b>166</b>
<b>TORQUE RODS.....</b>	<b>169</b>

## **WATER PUMPS & MISCELLANEOUS COMPONENTS 170**

<b>WATER PUMPS.....</b>	<b>170</b>
<b>RADIATOR ACCESSORIES.....</b>	<b>171</b>
<b>FAN CLUTCH.....</b>	<b>171</b>
<b>FANS.....</b>	<b>172</b>
<b>COOLING COMPONENTS.....</b>	<b>173</b>
<b>PRIMER PUMP.....</b>	<b>175</b>

## **CLUTCH COMPONENTS 176**

<b>CONTROL CABLES.....</b>	<b>178</b>
----------------------------	------------





## AIR BRAKE COMPONENTS

### SPRING BRAKE ASSEMBLIES



FortProUSA#	Replaces	Type	Notes
<b>F224730</b>	19QE441RP1	30/30	Serviceable
<b>F224746</b>	N/A	30/30	Sealed
<b>F224797</b>	N/A	30/30 Long Stroke	Sealed
<b>F224729</b>	19QE410AP3	24/24	Serviceable
<b>F224756</b>	N/A	24/24	Sealed
<b>F224794</b>	19QE453RP3	24/30	Serviceable
<b>F224795</b>	N/A	24/30	Sealed
<b>F224796</b>	N/A	36/36	Sealed

### SERVICE CHAMBER ASSEMBLIES



FortProUSA#	Replaces	Type	Notes
<b>F224728</b>	288813	30	Serviceable
<b>F224727</b>	288808	24	Serviceable
<b>F224726</b>	288803	20	Serviceable
<b>F224725</b>	288799	16	Serviceable

### BRAKE CHAMBER DIAPHRAGMS



FortProUSA#	Replaces	Type	Diameter
<b>F224734</b>	236668	30	7 - 7/8"
<b>F224733</b>	236667	24	7"
<b>F224732</b>	236666	20	6 - 5/8"
<b>F224731</b>	236665	16	6 - 3/16"
<b>F224758</b>	236664	12	5 - 1/2"





## AIR BRAKE COMPONENTS

### MANUAL SLACK ADJUSTERS

FortProUSA#	Replaces	Spline Teeth	Notes
<b>F224769</b>	278302	1-1/4" - 10	4.5" - 5.5"
<b>F224736</b>	278303	1-1/4" - 10	5" - 6"
<b>F224735</b>	278323	1-1/2" - 10	5" - 6" - 7"
<b>F224770</b>	278326	1-1/2" - 10	4.5" - 5.5" - 6.5"
<b>F224737</b>	286965	1-1/2" - 28	5" - 6"
<b>F224771</b>	288753	1-1/2" - 28	5.5" - 6.5"
<b>F224772</b>	288282	1-1/2" - 28	5" - 6" - 7"
<b>F224774</b>	KN55001	1-1/4" - 24	5.5"
<b>F224738</b>	283411	1-5/8" - 37	6"

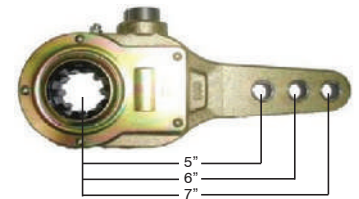
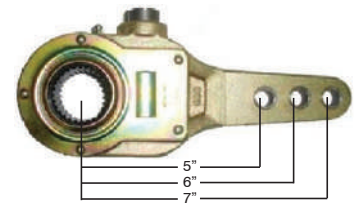

### AUTOMATIC SLACK ADJUSTERS - MERITOR STYLE

FortProUSA#	Replaces	Spline Teeth	Notes
<b>F225051</b>	R801041	1-1/2" - 10	5.5"
<b>F225052</b>	R801042	1-1/2" - 10	6"
<b>F225053</b>	R801073	1-1/2" - 28	5.5"
<b>F225054</b>	R801074	1-1/2" - 28	6"
<b>F225055</b>	R801004	1-1/4" - 10	5.5"
<b>F225056</b>	R801003	1-1/4" - 24	5.5"





## AIR BRAKE COMPONENTS

### AUTOMATIC SLACK ADJUSTERS - BENDIX STYLE

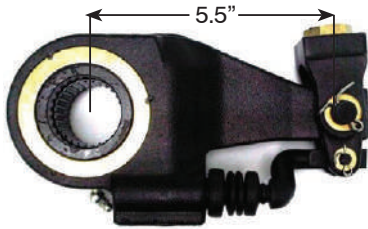
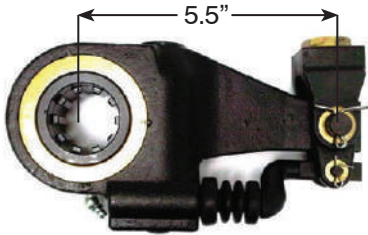

FortProUSA#	Replaces	Type	Notes
<b>F224773</b>	065164	1-1/4" - 10	5.5"
<b>F224750</b>	065167	1-1/4" - 24	5.5"
<b>F224751</b>	065170	1-1/2" - 10	5.5"
<b>F224752</b>	065172	1-1/2" - 10	6"
<b>F224753</b>	065174	1-1/2" - 28	5.5"
<b>F224754</b>	065176	1-1/2" - 28	6"
<b>F224926</b>	065178	1-5/8" - 37	5.5"
<b>F224755</b>	065179, 065194	1-5/8" - 37	6"

### AUTOMATIC SLACK ADJUSTERS - HALDEX STYLE



FortProUSA#	Replaces	Type	Notes
<b>F224927</b>	40010140	1-1/2" - 28	5" - 6"
<b>F224928</b>	40010141	1-1/2" - 28	5.5" - 6.5"
<b>F224929</b>	40010143	1-1/2" - 10	5.5" - 6.5"
<b>F224930</b>	40010144	1-1/2" - 28	6"
<b>F224931</b>	40010211	1-1/2" - 28	5.5"
<b>F224932</b>	40010212	1-1/2" - 28	6"







## AIR BRAKE COMPONENTS

### AUTOMATIC SLACK ADJUSTERS - GUNITE STYLE

FortProUSA#	Replaces	Spline Teeth	Notes
<b>F225061</b>	AS1132	1-1/2" - 10	5.5"
<b>F225062</b>	AS1133	1-1/2" - 10	6"
<b>F225063</b>	AS1140	1-1/2" - 28	5.5"
<b>F225064</b>	AS1141	1-1/2" - 28	6"
<b>F225065</b>	AS1136	1-1/4" - 10	5.5"
<b>F225066</b>	AS1138	1-1/4" - 24	5.5"



### AUTOMATIC SLACK ADJUSTERS - CREWSON STYLE



FortProUSA#	Replaces	Spline Teeth	Notes
<b>F225057</b>	CB22102	1-1/2" - 28	5.5" - 6.5"
<b>F225058</b>	CB22103	1-1/2" - 28	5" - 6"
<b>F225059</b>	CB21102	1-1/2" - 10	5.5" - 6.5"
<b>F225060</b>	CB21103	1-1/2" - 10	5" - 6"





6300 NW 84 AVE  
MIAMI, FL 33166 - USA

Heavy Duty Truck & Trailer Parts

## LINED BRAKE SHOES

### 4515E / 4515P - LINED BRAKE SHOE



FortproUSA#: **F224840**

Replaces: 4515E / 4515P

Notes: 23K, 16 1/2" X 7"

### 4515Q - LINED BRAKE SHOE



FortproUSA#: **F224841**

Replaces: 4515Q

Notes: 23K, 16-1/2" X 7"

### 4707Q - LINED BRAKE SHOE



FortproUSA#: **F224855**

Replaces: 4707Q

Notes: 23K, 16-1/2" X 7"

### 4709ESII - LINED BRAKE SHOE



FortproUSA#: **F224844**

Replaces: 4709ESII

Notes: 23K, 16-1/2" X 7"





# LINED BRAKE SHOES

## 4311E - LINED BRAKE SHOE

<b>FortproUSA#: F224838</b>
<b>Replaces: 4311E</b>
<b>Notes: 23K, 16-1/2" X 7"</b>



## 4524Q - LINED BRAKE SHOE

<b>FortproUSA#: F224859</b>
<b>Replaces: 4524Q</b>
<b>Notes: 23K, 16-1/2" X 5" (Mack)</b>



## 4702Q - LINED BRAKE SHOE

<b>FortproUSA#: F224846</b>
<b>Replaces: 4702Q</b>
<b>Notes: 23K, 15" X 4"</b>



## 1443E - LINED BRAKE SHOE

<b>FortproUSA#: F224857</b>
<b>Replaces: 1443E</b>
<b>Notes: 23K, 15" X 4"</b>





6300 NW 84 AVE  
MIAMI, FL 33166 - USA

Heavy Duty Truck & Trailer Parts

## LINED BRAKE SHOES

### 1308E - LINED BRAKE SHOE



FortproUSA#: **F224848**

Replaces: 1308E

Notes: 23K, 15" X 4"

### 1308Q - LINED BRAKE SHOE



FortproUSA#: **F224861**

Replaces: 1308Q

Notes: 23K, 15" X 4"

## UNLINED BRAKE SHOES

### 4515E / 4515P - UNLINED BRAKE SHOE



FortproUSA#: **F224842**

Replaces: 4515E / 4515P

Notes: 16-1/2" X 7"

### 4515Q - UNLINED BRAKE SHOE



FortproUSA#: **F224843**

Replaces: 4515Q

Notes: 16-1/2" X 7"



## UNLINED BRAKE SHOES

### 4707Q UNLINED BRAKE SHOE

<b>FortproUSA#:</b> F224856
<b>Replaces:</b> 4707Q
<b>Notes:</b> 16-1/2" X 7"



### 4709ESII - UNLINED BRAKE SHOE

<b>FortproUSA#:</b> F224845
<b>Replaces:</b> 4709ESII
<b>Notes:</b> 16-1/2" X 7"



### 4311E - UNLINED BRAKE SHOE

<b>FortproUSA#:</b> F224839
<b>Replaces:</b> 4311E
<b>Notes:</b> 16-1/2" X 7"



### 4524Q - UNLINED BRAKE SHOE

<b>FortproUSA#:</b> F224860
<b>Replaces:</b> 4524Q
<b>Notes:</b> 16-1/2" X 5" (Mack)





6300 NW 84 AVE  
MIAMI, FL 33166 - USA

Heavy Duty Truck & Trailer Parts

## UNLINED BRAKE SHOES

### 4702Q - UNLINED BRAKE SHOE



FortproUSA#: **F224847**

Replaces: 4702Q

Notes: 15" X 4"

### 1443E - UNLINED BRAKE SHOE



FortproUSA#: **F224858**

Replaces: 1443E

Notes: 15" X 4"

### 1308E - UNLINED BRAKE SHOE



FortproUSA#: **F224849**

Replaces: 1308E

Notes: 15" X 4"

### 1308Q - UNLINED BRAKE SHOE



FortproUSA#: **F224862**

Replaces: 1308Q

Notes: 15" X 4"





## NEW LINED SHOE BOX KIT

### NEW LINED SHOE BOX KIT



\* Kit part numbers contain 2 new lined shoes and 1 hardware kit.

FortProUSA#	Shoe Type	Brake Size	Notes
<b>F224911</b>	4515E / 4515P	16 1/2" X 7"	23K
<b>F224910</b>	4515Q	16 1/2" X 7"	23K
<b>F224914</b>	4707Q	16 1/2" X 7"	23K
<b>F224912</b>	4709ESII	16 1/2" X 7"	23K
<b>F224913</b>	4311E	16 1/2" X 7"	23K
<b>F224918</b>	4524Q	16 1/2" X 5"	23K
<b>F224915</b>	4702Q	15" X 4"	23K
<b>F224917</b>	1443E	15" X 4"	23K
<b>F224916</b>	1308E	15" X 4"	23K
<b>F224919</b>	1308Q	15" X 4"	23K
<b>F224920</b>	4720Q	16 1/2" X 5"	23K
<b>F224921</b>	4715Q	16 1/2" X 6"	23K
<b>F224922</b>	4514	16 1/2" X 6"	23K
<b>F224923</b>	4719	16 1/2" X 5"	23K
<b>F224924</b>	4710Q	15" X 8 5/8"	23K
<b>F224925</b>	4725	16 1/2" X 6"	23K





## BRAKE LINING SETS

### ■ BRAKE LINING SETS

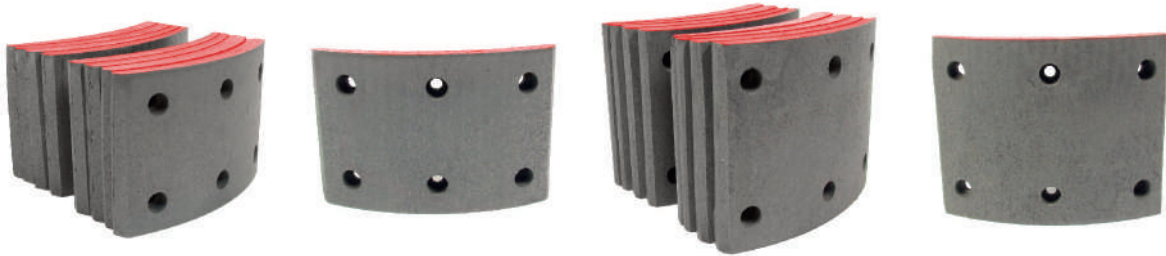

FortProUSA#	Reference	PCS/Set	Notes
<b>F224950</b>	4515	8	23K
<b>F224953</b>	4707	8	23K
<b>F224951</b>	4709	8	23K
<b>F224952</b>	4311	8	23K
<b>F224957</b>	4524	8	23K
<b>F224954</b>	4702	8	23K
<b>F224956</b>	1443	4	23K
<b>F224955</b>	1308	4	23K
<b>F224958</b>	4527	8	23K
<b>F224959</b>	4710	8	23K
<b>F224960</b>	4715	8	23K
<b>F224961</b>	4719	8	23K
<b>F224962</b>	4725	8	23K
<b>F224963</b>	4726	8	23K
<b>F224964</b>	4714	8	23K
<b>F224830</b>	9144	8	23K Isuzu (NPR)
<b>F224831</b>	9107	8	23K Ford Cargo 815
<b>F224832</b>	4705	8	23K Iveco Stralis
<b>F224833</b>	4720	8	23K







Heavy Duty Truck & Trailer Parts

# BRAKE DRUMS

## BRAKE DRUMS



FortProUSA#	Reference	Description	Wheel Type	Bolt Holes No.
<b>F224935</b>	3600AX	BRAKE DRUM, REAR TRUCK	DISC	10
<b>F224936</b>	3141B	BRAKE DRUM, REAR TRUCK	DISC	8
<b>F224937</b>	2983C	BRAKE DRUM, TRAILER	Spoke	5/6
<b>F224938</b>	3721AX	BRAKE DRUM, FRONT TRUCK	DISC	10
<b>F224939</b>	3800X	BRAKE DRUM, FRONT TRUCK	DISC	10
<b>F224940</b>	8656	BRAKE DRUM, REAR TRUCK	Spoke	6
<b>F224941</b>	3197	BRAKE DRUM, REAR TRUCK	Spoke	6
<b>F224942</b>	3826	BRAKE DRUM, TRAILER	Spoke	6
<b>F224943</b>	3141	REAR TRUCK	DISC	10
<b>F224944</b>	3402X	REAR TRUCK	DISC	10
<b>F224945</b>	3166	TRAILER	DISC	10
<b>F224946</b>	3758	FRONT TRUCK	DISC	10
<b>F224947</b>	3687	FRONT TRUCK	DISC	10
<b>F224933</b>	3120	Brake Drum	Disc	10
<b>F224934</b>	3018A	Brake Drum	Spoke / Disc	10
<b>F224948</b>	2997	Brake Drum	Spoke	5
<b>F224949</b>	3595A	Brake Drum	Disc	10
<b>F224965</b>	3295A	Brake Drum	Spoke	5
<b>F224966</b>	3744X	Brake Drum	Disc	10
<b>F224980</b>	68765F, 2546C	Brake Drum	Spoke	5/6
<b>F224981</b>	2705	Brake Drum	Disc	10
<b>F224982</b>	3807	Brake Drum	Disc	10
<b>F224983</b>	3158X	Brake Drum	Disc	10





## Heavy Duty Truck & Trailer Parts

# HUBS

### TRUCK & TRAILER HUBS



FortproUSA#: **F276298**

**Replaces:** 15984, 2023, E-9348

**Notes:** Inner bearing cup HM218210, Inner bearing cone HM218248, Outer bearing cup HM212011, Outer bearing cone HM212049, No. Studs 10

### TRUCK & TRAILER HUBS



FortproUSA#: **F276299**

**Replaces:** 15502, 2323, E-9349

**Notes:** Inner bearing cup HM518410, Inner bearing cone HM518445, Outer bearing cup HM518410, Outer bearing cone HM518445, No. Studs 10

### TRUCK & TRAILER HUBS



FortproUSA#: **F276300**

**Replaces:** 2643

**Notes:** Inner bearing cup 592A, Inner bearing cone 594A & 598A, Outer bearing cup 572, Outer bearing cone 580, No. Studs 10



# BRAKE REPAIR KITS

**FortproUSA#: F224804**

**Replaces:** E2769SHD, KIT8000HD

**Notes:** 4515Q, 4707Q, 4524Q, 4514Q, 4551Q, 4549Q



**FortproUSA#: F224810**

**Replaces:** E1816SHD, KIT9001

**Notes:** 4515E / 4515P

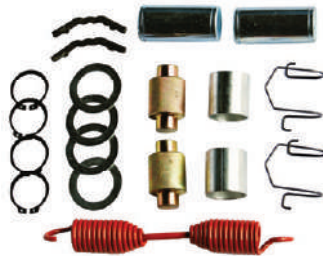

**FortproUSA#: F224803**

**Replaces:** E10244S

**Notes:** 4709ESII



**FortproUSA#: F224811**

**Replaces:** E1887AHD

**Notes:** 4311E

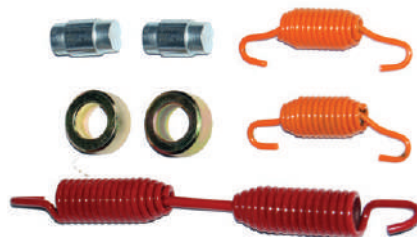



## BRAKE REPAIR KITS

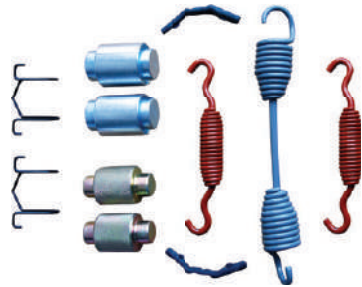

FortproUSA#: **F224813**

Replaces: E9064, KIT8824HD

Notes: 4702Q



FortproUSA#: **F224814**

Replaces: E5139

Notes: 1308E, 1443E



FortproUSA#: **F224815**

Replaces: E3869, KIT8029

Notes: 1308Q



FortproUSA#: **F224805**

Replaces: E5481

Notes: 4709ES





# BRAKE REPAIR KITS

<b>FortproUSA#:</b> F224806
<b>Replaces:</b> E9644
<b>Notes:</b> 4715, 4720

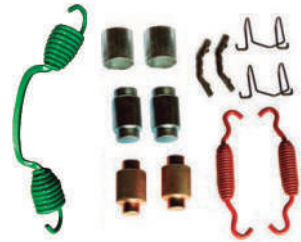

# BRAKE SHOE RETURN SPRINGS

<b>FortproUSA#:</b> F224816
<b>Replaces:</b> E9643
<b>Notes:</b> L 9 1/16", OD 1 3/16" for 16 1/2" Brakes



<b>FortproUSA#:</b> F224798
<b>Replaces:</b> E3490B, 2258W803
<b>Notes:</b> L 8-3/8", OD 1-1/4" for 16-1/2" Brakes



<b>FortproUSA#:</b> F224800
<b>Replaces:</b> E18808, 2258Z416
<b>Notes:</b> L 8", OD 1-1/4" for 16-1/2" Brakes





# BRAKE SHOE RETURN SPRINGS



**FortproUSA#: F224799**  
**Replaces:** E1428A, 78580  
**Notes:** L 10-13/16", OD 1-1/8" for 16-1/2" Brakes



**FortproUSA#: F224809**  
**Replaces:** E2804, 100091  
**Notes:** L 11- 3/8", OD 1-1/4" for 18" Brakes



**FortproUSA#: F224801**  
**Replaces:** E1418, 70326  
**Notes:** L 4-17/32", OD 1"



**FortproUSA#: F224802**  
**Replaces:** E2767, 2258Q615  
**Notes:** L 5-1/2", OD 3/4"



**FortproUSA#: F224808**  
**Replaces:** E2805, 1000092  
**Notes:** L 4-5/8", OD 1-1/4"



**FortproUSA#: F224807**  
**Replaces:** E5088, 2258X804  
**Notes:** L 6-5/16", OD 3/4"



## BRAKE COMPONENTS

### ROLLER

FortproUSA#: **F225002**

Replaces: E595 / Notes: L 25/32", OD 1-5/8", ID 15/16"



### ROLLER PIN

FortproUSA#: **F225003**

Replaces: E596A / Notes: L 1-25/32", OD 59/64"



### ROLLER

FortproUSA#: **F225008**

Replaces: E523 / Notes: L 2-7/32", OD 1-1/4"



### ROLLER

FortproUSA#: **F225009**

Replaces: E781 / Notes: L 2-7/32", OD 1-3/8"



### ANCHOR PIN

FortproUSA#: **F225013**

Replaces: E512 / Notes: L 2-7/8", OD 1-1/4"



### ANCHOR PIN

FortproUSA#: **F225014**

Replaces: E502 / Notes: L 3-3/4", OD 1-1/4"



### ROLLER RETAINER

FortproUSA#: **F225023**

Replaces: E539



### SPRING CLIP

FortproUSA#: **F225026**

Replaces: E747 / Notes: L 2 3/4", OD 1/4"





## BRAKE COMPONENTS

### LOCK RING



FortproUSA#: **F225019**

Replaces: E801 / Notes: ID 1-1/8", Thickness 1/16"

### STEEL RIVET



FortproUSA#: **F224969**

Replaces: 10-10 / Notes: Head 1/2", Body 1/4", L 10/16"

### STEEL RIVET



FortproUSA#: **F224968**

Replaces: 10-9 / Notes: Head 1/2", Body 1/4", L 9/16"

### STEEL RIVET



FortproUSA#: **F224967**

Replaces: 10-8 / Notes: Head 1/2", Body 1/4", L 1/2"

### CAMSHAFT LOCK RING



FortproUSA#: **F225018**

Replaces: E526, 1229Z1118 / Notes: I.D. 1-31/64", Thickness 1/16"

### CAMSHAFT LOCK



FortproUSA#: **F225020**

Replaces: E3234, 804017

### CAMSHAFT BUSHING



FortproUSA#: **F224992**

Replaces: E2551, 1225X804 / Notes: L 1-23/32", OD 1-7/8" ID 1-1/2"

### CAMSHAFT BUSHING



FortproUSA#: **F224993**

Replaces: E536, 1225N378 / Notes: L 1-1/4", OD 1-7/8", ID 1-1/2"







# Heavy Duty Truck & Trailer Parts

## CAMSHAFT REPAIR KITS

**FortproUSA#: F224994**

**Replaces:** KIT8042, E3993B / **Notes:** For Rockwell 15" & 16-1/2" Drive Axels "Q" & "Q+" Brakes



**FortproUSA#: F224995**

**Replaces:** KIT9078, E2086B / **Notes:** For Rockwell 16-1/2" & 18" Drive Axels "P" Brake, Universal

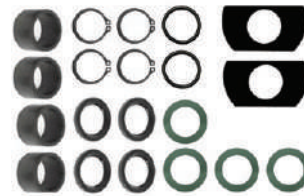

**FortproUSA#: F224996**

**Replaces:** E9080, HBK3217 / **Notes:** For Rockwell 16-1/2", "P" & "Q" Drive Axel Brakes, W / 2-1/2" Spider Offset



**FortproUSA#: F224997**

**Replaces:** E2125, 78500 / **Notes:** For 15" & 16-1/2" Brakes Eaton Seft-Contained Drive Axels



**FortproUSA#: F225001**

**Replaces:** KIT8048, 3520AHD / **Notes:** For 16-1/2" Late Model Rockwell 4000-6000 Series Trailer Axels



**FortproUSA#: F224998**

**Replaces:** E2469 / **Notes:** For Spicer, Forge Axles Late Model



**FortproUSA#: F224999**

**Replaces:** E9079HD / **Notes:** For Rockwell Q, Q+ Trailer Axle - Bolt on Bushing





## AIR COMPONENTS

### AD-IP AIR DRYER



FortproUSA#: **F224898**

Replaces: 065612, 109477

### AD-IP CARTRIDGE



FortproUSA#: **F224850**

Replaces: 065624

### AD-IS AIR DRYER



FortproUSA#: **F224868**

Replaces: 801266, 5010694,  
5015533, 5015534,  
5010696X

### SYSTEM SAVER AIR DRYER



FortproUSA#: **F224677**

Replaces: R955205





## AIR COMPONENTS

### AD-SP AIR DRYER

FortproUSA#: **F224894**

Replaces: 800887,065691,26QE433

Notes: Delivery Port (1) 1/2" P.T.  
Supply Port (1) 1/2" P.T.  
Control Port (1) 1/4" P.T.



### AIR DRYER SYSTEM SAVER

FortproUSA#: **F224870**

Replaces: 4324711010, 4324710010

Notes: System Saver 1200 Plus with Oil  
Coalescing Cartridge

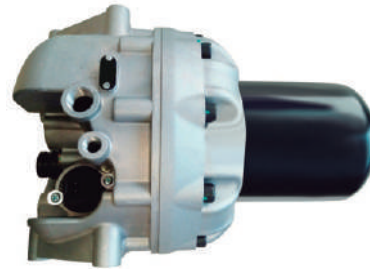

### PURGE VALVE KIT

FortproUSA#: **F224895**

Replaces: R950014



### HEATER REPAIR KIT

FortproUSA#: **F224896**

Replaces: R950015



### SINGLE CHECK VALVE

FortproUSA#: **F224897**

Replaces: 431003100





## AIR COMPONENTS

### D-2 GOVERNOR



FortproUSA#: **F224710**

Replaces: 275491, KN18530,  
20QE275P1, LGV3645

Notes: All Ports 1/8" P.T.

### AD-9 AIR DRYER



FortproUSA#: **F224680**

Replaces: 065225, 26QE377

Notes: Supply Port (1) 1/2" P.T.  
Delivery Port (1) 1/2" P.T.

### AD-9 CARTRIDGE



FortproUSA#: **F224785**

Replaces: 107796, 1685515C91

Notes: Dia. 5.85", High 9.5"

### AD-9 VALVE PURGE



FortproUSA#: **F224681**

Replaces: 800405, 5004341





## Heavy Duty Truck & Trailer Parts

# AIR COMPONENTS

### AD-SP CARTRIDGE

FortproUSA#: **F224678**

Replaces: 109994

Notes: Dia. 5.62" High 5"



### AD-4 CARTRIDGE

FortproUSA#: **F224787**

Replaces: 104358

Notes: Dia. 5.85" High 10.35"



### ABS RELAY EMERGENCY VALVE

FortproUSA#: **F224605**

Replaces: 4725001230

Notes: Assemble

FortproUSA#: **F224608**

Replaces: 4725001200

Notes: Assemble

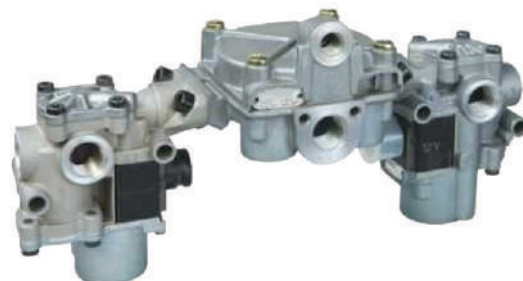



## Heavy Duty Truck & Trailer Parts

# AIR COMPONENTS

### MANUAL DRAIN VALVE



FortproUSA#: **F224786**

Replaces: 12105

Notes: 1/4" P.T., 5 ft. Long Cable

### DV-2 DRAIN VALVE



FortproUSA#: **F224656**

Replaces: 281923, 282569, 20QE1189

Notes: 1/4" P.T.

Repair Kit: FortProUSA#: F224632  
Replaces: 282134

### E-3 FOOT VALVE



FortproUSA#: **F224706**

Replaces: 277863, KN22100

Notes: Supply Ports (2) 1/2" P.T.  
Auxiliary Ports (2) 1/4" P.T.  
Delivery Ports (4) 1/2" P.T.

Repair Kit: FortProUSA#: F224633  
Replaces: 289329

### E-5 FOOT VALVE



FortproUSA#: **F224683**

Replaces: 279950

Notes: Supply Port (1) 1/2" P.T.  
Supply Port (1) 1/8" P.T.  
Supply Ports (5) 1/4" P.T.  
Delivery Ports (2) 1/4" P.T.  
Mounting Stud (3) 3/8" 24

Repair Kit: FortProUSA#: F224634  
Replaces: 281084



## AIR COMPONENTS

### E-6 FOOT VALVE

<b>FortproUSA#: F224707</b>
<b>Replaces:</b> 286171, KN22140, 20QE3114R
<b>Notes:</b> Supply Ports (4) 3/8" P.T. Delivery Ports (4) 3/8" P.T.
<b>Repair Kit:</b> FortProUSA#: F224635 Replaces: 289335



### E-7 FOOT VALVE

<b>FortproUSA#: F224684</b>
<b>Replaces:</b> 288383
<b>Notes:</b> Supply Ports (4) 1/4", (2) 1/2", (1) 1/8" P.T. Delivery Ports (4) 1/4", (2) 1/2" P.T. Mounting Holes (3) 3/8" - 16
<b>Repair Kit:</b> FortProUSA#: F224636 Replaces: 289352



### E-8P FOOT VALVE

<b>FortproUSA#: F224682</b>
<b>Replaces:</b> 800629, 20QE3296AM
<b>Notes:</b> Supply Ports (4) 3/8" P.T. Delivery Ports (4) 3/8" P.T. Auxiliary Ports (1) 3/8" P.T.
<b>Repair Kit:</b> FortProUSA#: F224635 Replaces: 289335



### TREADLE

<b>FortproUSA#: F224688</b>
<b>Replaces:</b> SN4017A, 3MX451
<b>Notes:</b> 45° Angle



## AIR COMPONENTS

### BP-R1 RELAY VALVE



**FortproUSA#: F224783**

**Replaces:** 065146

**Notes:** Delivery Ports (2) 1/2" , (2) 3/8" P.T.  
Supply Port (1) 1/2" P.T.  
Control Port (1) 1/8" P.T.  
Service Port (1) 1/4" P.T.

**Repair Kit:** FortProUSA#: F224639  
Replaces: 106932

### R-5 RELAY VALVE



**FortproUSA#: F224689**

**Replaces:** KN28060, 229467

**Notes:** Delivery Ports (2) 3/8" P.T.  
Reservoir Ports (2) 1/2" P.T.  
Control Port (1) 3/8" P.T.  
4.6 psig Cracking Pressure

**Repair Kit:** FortProUSA#: F224640  
Replaces: RN10HK

### R-6 RELAY VALVE



**FortproUSA#: F224704**

**Replaces:** 280375, 279180

**Notes:** Supply Ports (1) 1/2" P.T.  
Delivery Ports (4) 3/8" P.T.  
Service Port (1) 1/4" P.T.

**Repair Kit:** FortProUSA#: F224741  
Replaces: 280856

### R-8 RELAY VALVE



**FortproUSA#: F224690**

**Replaces:** 286370

**Notes:** Supply Ports (2) 3/4" P.T.  
Delivery Ports (2) 1/2" P.T.  
Service Port (1) 1/4" P.T.

**Repair Kit:** FortProUSA#: F224641  
Replaces: 287370





## Heavy Duty Truck & Trailer Parts

# AIR COMPONENTS

### R-12 RELAY VALVE

<b>FortproUSA#:</b> F224702
<b>Replaces:</b> 102626, A86473
<b>Notes:</b> Supply Port (1) 1/2" P.T. Delivery Ports (4) 1/2" P.T. Service Port (1) 1/4" P.T. 4 psig Cracking Pressure
<b>Repair Kit:</b> FortProUSA#: F224642 Replaces: 102802



### R-12H RELAY VALVE

<b>FortproUSA#:</b> F224637
<b>Replaces:</b> 103009, 102537, 20QE347, KN28140, 1677541C91
<b>Notes:</b> Supply Ports (2) 3/4" P.T. Delivery Ports (2) 1/2" P.T. Service Port (1) 1/4" P.T. 4 psig Cracking Pressure



### R-12H RELAY VALVE

<b>FortproUSA#:</b> F224709
<b>Replaces:</b> 065125, 20QE458
<b>Notes:</b> Supply Ports (2) 1/2" P.T. Delivery Ports (2) 1/2" P.T. Service Port (1) 1/4" P.T. 5.5 psig Cracking Pressure
<b>Repair Kit:</b> FortProUSA#: F224642 Replaces: 102802



### R-14 RELAY VALVE

<b>FortproUSA#:</b> F224716
<b>Replaces:</b> 103028
<b>Notes:</b> Supply Port (1) 1/2" P.T. Delivery Ports (4) 1/2" P.T. Service Ports (1) 1/4" P.T. Balance Ports (1) 1/8" P.T. 4 psig Cracking Pressure
<b>Repair Kit:</b> FortProUSA#: F224642 Replaces: 102802





## Heavy Duty Truck & Trailer Parts

# AIR COMPONENTS

### R-14H RELAY VALVE



<b>FortproUSA#:</b> F224713
<b>Replaces:</b> 104574
<b>Notes:</b> Supply Ports (2) 1/2" P.T. Delivery Ports (2) 1/2" P.T. Control Port (1) 1/4" P.T. Balance Port (1) 1/8" P.T. 4 psig Cracking Pressure
<b>Repair Kit:</b> FortProUSA#: F224642 Replaces: 102802

### R-14H RELAY VALVE



<b>FortproUSA#:</b> F224717
<b>Replaces:</b> 103010
<b>Notes:</b> Supply Ports (2) 3/4" P.T., (1) 1/2" P.T. Delivery Ports (2) 1/2" P.T. Service Port (1) 1/8" P.T., Balance Port (1) 1/8" P.T. 6 psig Cracking Pressure
<b>Repair Kit:</b> FortProUSA#: F224642 Replaces: 102802

### RG-2 RELAY VALVE



<b>FortproUSA#:</b> F224691
<b>Replaces:</b> KN28510
<b>Notes:</b> Supply Port (1) 3/8" P.T., (1) 1/2" P.T. Delivery Ports (2) 3/8" P.T. Control Port (1) 1/4" P.T. 6 psig Cracking Pressure
<b>Repair Kit:</b> FortProUSA#: F224643 Replaces: RN10HM

### RG-2 RELAY VALVE



<b>FortproUSA#:</b> F224720
<b>Replaces:</b> KN28500
<b>Notes:</b> Supply Ports (2) 3/8" P.T. Delivery Ports (2) 3/8" P.T. Control Port (1) 1/4" P.T. 6 psig Cracking Pressure
<b>Repair Kit:</b> FortProUSA#: F224643 Replaces: RN10HM





## Heavy Duty Truck & Trailer Parts

# AIR COMPONENTS

### A1000S EMERGENCY RELAY VALVE

<b>FortproUSA#: F224744</b>
<b>Replaces:</b> A1000S
<b>Notes:</b> Supply Port (1) 1/2" P.T. Delivery Ports (4) 1/4" P.T. Control Port (2) 1/4" P.T. Emergency Supply Port (1) 1/4" P.T.
<b>Repair Kit:</b> FortProUSA#: F224644 Replaces: 10005A



### EMERGENCY RELAY TRAILER VALVE

<b>FortproUSA#: F224692</b>
<b>Replaces:</b> 110200, KN30010
<b>Notes:</b> Supply Port (1) 3/4" P.T. Delivery Ports (4) 3/8" P.T. Control Port (2) 1/4" P.T. Emergency Supply Port (1) 1/4" P.T. 4-5 psig Cracking Pressure
<b>Repair Kit:</b> FortProUSA#: F224645 Replaces: 110201



### EMERGENCY RELAY VALVE

<b>FortproUSA#: F224701</b>
<b>Replaces:</b> KN30400
<b>Notes:</b> Supply Ports (1) 3/4" P.T. Delivery Ports (4) 3/8" P.T. Service Port (1) 1/4" P.T. Emergency Supply Port (1) 1/4" P.T. 4.5 psig Cracking Pressure
<b>Repair Kit:</b> FortProUSA#: F224646 Replaces: RN10HL



### EMERGENCY RELAY VALVE

<b>FortproUSA#: F224708</b>
<b>Replaces:</b> KN30300
<b>Notes:</b> Supply Ports (1) 3/4" P.T. Delivery Ports (4) 1/4" P.T. Service Port (1) 1/4" P.T. Emergency Supply Port (1) 1/4" P.T. 4.5 psig Cracking Pressure
<b>Repair Kit:</b> FortProUSA#: F224646 Replaces: RN10HL





## Heavy Duty Truck & Trailer Parts

# AIR COMPONENTS

### RE-6 EMERGENCY RELAY VALVE



**FortproUSA#:** F224703

**Replaces:** 281865

**Notes:** Supply Ports (1) 3/4" P.T., (1) 3/8" P.T.  
Delivery Ports (2) 3/8" P.T., (2) 1/4" P.T.  
Service Port (1) 1/4" P.T.  
Emergency Supply Port (1) 1/4" P.T.

**Repair Kit:** FortProUSA#: F224740  
Replaces: 282812

### FF-2 FULL FUNCTION TRAILER VALVE



**FortproUSA#:** F224693

**Replaces:** KN28601

**Notes:** Supply Port (1) 3/8" P.T.  
Control Port (1) 1/4" P.T.  
Reservoir Ports (1) 1/2" P.T.  
Service Brake Ports (4) 3/8" P.T.  
Spring Brake Ports (2) 3/8" P.T.  
3 psig Cracking Pressure

### FF-2 FULL FUNCTION TRAILER VALVE



**FortproUSA#:** F224694

**Replaces:** KN28600

**Notes:** Supply Port (1) 3/8" P.T.  
Control Port (1) 1/4" P.T.  
Reservoir Ports (1) 3/4" P.T.  
Service Brake Ports (4) 3/8" P.T.  
Spring Brake Ports (2) 3/8" P.T.  
3 psig Cracking Pressure

### RT-4 MULTIFUNCTION TRAILER VALVE



**FortproUSA#:** F224790

**Replaces:** KN26000

**Notes:** Supply Ports (2) 3/8" P.T.  
Delivery Ports (4) 3/8" P.T.  
Control Port (1) 3/8" P.T.  
Reservoir Port (1) 1/2" P.T., (1) 3/8" P.T.  
55 psig Closing Pressure





Heavy Duty Truck & Trailer Parts

# AIR COMPONENTS

## TRAILER BRAKE CONTROL VALVE

<b>FortproUSA#:</b> F224695
<b>Replaces:</b> KN20541
<b>Notes:</b> All Ports 1/4" P.T.



## TC-2 CONTROL TRAILER VALVE

<b>FortproUSA#:</b> F224718
<b>Replaces:</b> 276793, 20QE351AP3
<b>Notes:</b> All Ports 1/4" P.T.
<b>Repair Kit:</b> FortProUSA#: F224647 Replaces: 276122



## TC-2 CONTROL TRAILER VALVE

<b>FortproUSA#:</b> F224696
<b>Replaces:</b> KN20561
<b>Notes:</b> All Ports 1/4" P.T.
<b>Repair Kit:</b> FortProUSA#: F224638 Replaces: RN10GJ



## QR-1 QUICK RELEASE VALVE

<b>FortproUSA#:</b> F224697
<b>Replaces:</b> 229859, KN32005
<b>Notes:</b> Supply Port (1) 3/8" P.T. Delivery Ports (2) 3/8" P.T.
<b>Repair Kit:</b> FortProUSA#: F224627 Replaces: 245835





## Heavy Duty Truck & Trailer Parts

# AIR COMPONENTS

### QR-1 QUICK RELEASE VALVE



**FortproUSA#:** F224712

**Replaces:** 229860

**Notes:** Supply Port (1) 1/2" P.T.  
Delivery Ports (2) 3/8" P.T.

**Repair Kit:** FortProUSA#: F224627  
Replaces: 245835

### QR-1 QUICK RELEASE VALVE



**FortproUSA#:** F224687

**Replaces:** 229813

**Notes:** Supply Port (1) 3/8" P.T.  
Delivery Ports (2) 1/4" P.T.

**Repair Kit:** FortProUSA#: F224627  
Replaces: 245835

### QR-1 QUICK RELEASE VALVE



**FortproUSA#:** F224700

**Replaces:** 229844

**Notes:** Supply Port (1) 1/2" P.T.  
Delivery Ports (2) 1/4" P.T.

**Repair Kit:** FortProUSA#: F224627  
Replaces: 245835

### QR-1C QUICK RELEASE VALVE



**FortproUSA#:** F224699

**Replaces:** 289714, KN32041, 20QE2288

**Notes:** Supply Ports (1) 1/4" P.T.  
Delivery Ports (2) 3/8" P.T.  
Balance Port (1) 1/4" P.T.

**Repair Kit:** FortProUSA#: F224626  
Replaces: RN19AF





## AIR COMPONENTS

### QR-1C QUICK RELEASE VLVE

<b>FortproUSA#:</b> F224698
<b>Replaces:</b> 289182
<b>Notes:</b> Supply Ports (1) 1/4" P.T. Delivery Ports (2) 1/4" P.T. Balance Port (1) 1/4" P.T.
<b>Repair Kit:</b> FortProUSA#: F224626 Replaces: RN19AF



### TR-3 INVERSION VALVE

<b>FortproUSA#:</b> F102601
<b>Replaces:</b> 281459
<b>Notes:</b> Supply Port (1) 1/4" P.T. Delivery Port (1) 1/4" P.T. Control Port (1) 1/8" P.T. 25-40 psig Setting



### INVERSION VALVE

<b>FortproUSA#:</b> F224686
<b>Replaces:</b> KN28030
<b>Notes:</b> All Ports 1/4" P.T.
<b>Repair Kit:</b> FortProUSA#: F224631 Replaces: RN10EV



### TP-3DC TRACTOR PROTECTION VALVE

<b>FortproUSA#:</b> F224685
<b>Replaces:</b> 065706
<b>Notes:</b> Control Ports (2) 3/8" P.T., (1) 1/2" P.T. Supply Ports (2) 1/4" P.T., (1) 1/2" P.T. Stop Light Switch Part (1) 1/4" P.T.





## Heavy Duty Truck & Trailer Parts

# AIR COMPONENTS

### TP-3 TRACTOR PROTECTION VALVE



<b>FortproUSA#:</b> F224739
<b>Replaces:</b> 27900, KN34060, 401025, 20QE377
<b>Notes:</b> Service Tractor Port (1) 3/8" P.T. Service Trailer Port (1) 1/2" P.T. Emergency Tractor Port (1) 1/4" P.T. Emergency Trailer Port (1) 1/2" P.T.
<b>Repair Kit:</b> FortProUSA#: F224630 Replaces: 280858

### TP-5 TRACTOR PROTECTION VALVE

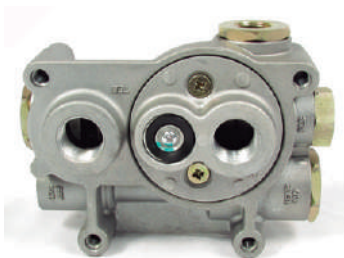

<b>FortproUSA#:</b> F224676
<b>Replaces:</b> 288605, 20QE3234
<b>Notes:</b> Stop Ligth Switch Port (1) 1/4" P.T. Service Ports (2) 3/8", (1) 1/2" P.T. Supply Ports (1) 3/8", (1) 1/2" P.T. Trailer Control (1) 3/8" P.T. Tractor Protection (1) 3/8" P.T.
<b>Repair Kit:</b> FortProUSA#: F224629 Replaces: 289061

### TRACTOR PROTECTION VALVE



<b>FortproUSA#:</b> F224675
<b>Replaces:</b> KN34110
<b>Notes:</b> Control Ports (3) 3/8" P.T. Tractor Emergency (1) 3/8" P.T. Trailer Service (1) 1/2" P.T. Trailer Emergency (1) 1/2" P.T.

### R-7 MODULATING VALVE



<b>FortproUSA#:</b> F224674
<b>Replaces:</b> 103081, 20QE3295
<b>Notes:</b> Supply Port (1) 3/8" P.T. Delivery Ports (2) 3/8" P.T. Balance Port (1) 1/4" P.T. Control Port (1) 1/4" P.T. 95 Psig Spring Brake (Release Pressure)







## AIR COMPONENTS

### RV-1 PRESSURE REDUCING VALVE

FortproUSA#: **F224673**

Replaces: 283590, 20QE2119P2, 347082R92

Notes: Supply Ports (1) 1/4" P.T.  
Delivery Port (1) 1/4" P.T.  
70 psig Delivery Pressure



### PR-2 PRESSURE PROTECTION VALVE

FortproUSA#: **F224672**

Replaces: 277147, 1676715C1

Notes: Supply Port (1) 1/4" P.T.  
Delivery Port (1) 1/4" P.T.  
65 psig Closing Pressure



### PR-4 PRESSURE PROTECTION VALVE

FortproUSA#: **F224671**

Replaces: KN31001, 20QE2128

Notes: Supply Port (1) 1/4" P.T.  
Delivery Port (1) 1/4" P.T.  
65 psig Open  
45 psig Closed



### PR-4 PRESSURE PROTECTION VALVE

FortproUSA#: **F224670**

Replaces: 20QE2326A

Notes: Supply Port (1) 1/4" P.T.  
Delivery Ports (2) 1/4" P.T.  
85 psig Open





## Heavy Duty Truck & Trailer Parts

# AIR COMPONENTS

### PR-4 PRESSURE PROTECTION VALVE



<b>FortproUSA#:</b> F224669
<b>Replaces:</b> 288323, 503511C91
<b>Notes:</b> Supply Port (1) 1/4" P.T. Delivery Port (1) 1/4" P.T. 70 psig Closing Pressure

### PR-4 PRESSURE PROTECTION VALVE



<b>FortproUSA#:</b> F224668
<b>Replaces:</b> 286500, 287827, 1676732C1
<b>Notes:</b> Supply Port (1) 1/4" P.T. Delivery Port (1) 1/4" P.T. 85 psig Closing Pressure

### SPRING BRAKE CONTROL VALVE



<b>FortproUSA#:</b> F224667
<b>Replaces:</b> 110170
<b>Notes:</b> Supply Ports (1) 3/8" P.T. Delivery Port (1) 3/8" P.T. Control Service (1) 3/8" P.T. Trailer Emergency (2) 1/2" P.T.

### SR-1 SPRING BRAKE VALVE

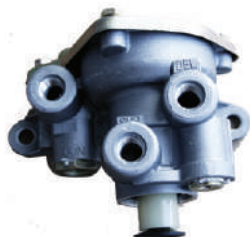

<b>FortproUSA#:</b> F224711
<b>Replaces:</b> 286364, 20QE311OR, 1693173C91
<b>Notes:</b> All Ports 1/4" P.T. 95 Psig Limiting Pressure
<b>Repair Kit:</b> FortProUSA#: F224625 Replaces: 287072





## Heavy Duty Truck & Trailer Parts

# AIR COMPONENTS

### SR-2 SPRING BRAKE VALVE

**FortproUSA#:** F224666

**Replaces:** 287376

**Notes:** Supply Port (1) 1/4" P.T.  
Delivery Ports (4) 3/8" P.T.  
Reservoir Ports (2) 1/4", (1) 3/4" P.T.  
Exhaust Ports (2) 3/8" P.T.



### SR-4 SPRING BRAKE VALVE

**FortproUSA#:** F224749

**Replaces:** 101112

**Notes:** Supply Port (1) 1/4" P.T.  
Service Port (1) 1/4" P.T.  
Delivery Ports (4) 3/8" P.T.  
Reservoir Ports (1) 3/4", (2) 1/4" P.T.  
Exhaust Port (1) 3/8" P.T.



### SR-4 SPRING BRAKE VALVE

**FortproUSA#:** F224665

**Replaces:** 101622

**Notes:** Supply Port (1) 1/4" P.T.  
Service Port (1) 1/4" P.T.  
Delivery Ports (4) 3/8" P.T.  
Reservoir Ports (1) 1/2", (2) 1/4" P.T.  
Exhaust Port (1) 3/8" P.T.



### SR-5 SPRING BRAKE VALVE

**FortproUSA#:** F224664

**Replaces:** 065437

**Notes:** Supply Port (1) 1/4" P.T.  
Service Port (1) 1/4" P.T.  
Delivery Ports (4) 3/8" P.T.  
Reservoir Ports (2) 1/4", (1) 3/4" P.T.  
Exhaust Port (1) 3/4" P.T.





## Heavy Duty Truck & Trailer Parts

# AIR COMPONENTS

### SR-5 SPRING BRAKE VALVE

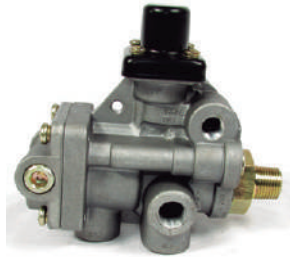

<b>FortproUSA#:</b> F224663
<b>Replaces:</b> 065439
<b>Notes:</b> Supply Port (1) 1/4" P.T. Service Ports (2) 1/4" P.T. Delivery Ports (4) 3/8" P.T. Reservoir Port (1) 1/2" P.T. Exhaust Port (1) Anti-Compounding Trailer Service Port (1) 1/4" P.T.

### LQ-2 FRONT AXLE VALVE



<b>FortproUSA#:</b> F224662
<b>Replaces:</b> 229505
<b>Notes:</b> Supply Port (1) 3/8" P.T. Delivery Ports (2) 3/8" P.T. Control Port (1) 1/4" P.T.
<b>Repair Kit:</b> FortProUSA#: F224624 Replaces: 282098

### LQ-4 FORNT AXLE VALVE

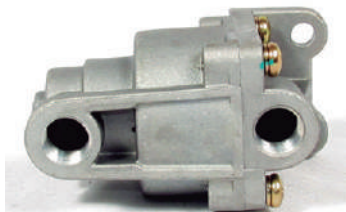

<b>FortproUSA#:</b> F224661
<b>Replaces:</b> 289144, 20QE3166R
<b>Notes:</b> Supply Port (1) 3/8" P.T. Delivery Port (1) 3/8" P.T. 60 Psig Equalizing Pressure
<b>Repair Kit:</b> FortProUSA#: F224623 Replaces: 289500

### LQ-4 FRONT AXLE VALVE

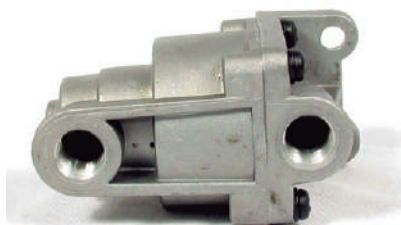

<b>FortproUSA#:</b> F224660
<b>Replaces:</b> 289148
<b>Notes:</b> Supply Port (1) 3/8" P.T. Delivery Port (1) 3/8" P.T. 10 Psig Holdoff Pressure





## Heavy Duty Truck & Trailer Parts

# AIR COMPONENTS

### LQ-5 FRONT AXLE VALVE

<b>FortproUSA#:</b> F224659
<b>Replaces:</b> 065154, 107196, 20QE3338, 1619733C91
<b>Notes:</b> Supply Port (1) 3/8" P.T. Delivery Port (1) 3/8" P.T. Control Port (1) 1/8" P.T.



### SC-1 CHECK VALVE

<b>FortproUSA#:</b> F224658
<b>Replaces:</b> KN23010
<b>Notes:</b> Supply Port (1) 3/8" P.T. Delivery Port (1) 3/8" P.T.



### SC-1 CHECK VALVE

<b>FortproUSA#:</b> F224719
<b>Replaces:</b> KN23000
<b>Notes:</b> Supply Port (1) 1/2" P.T. Delivery Port (1) 1/2" P.T.



### SC-1 CHECK VALVE

<b>FortproUSA#:</b> F224657
<b>Replaces:</b> KN23040
<b>Notes:</b> Supply Port (1) 3/4" P.T. Delivery Port (1) 3/4" P.T.





## AIR COMPONENTS

### SC-3 CHECK VALVE



<b>FortproUSA#:</b> F224655
<b>Replaces:</b> 800376, 20QE2207, 483144C92, 401017
<b>Notes:</b> Supply Port (1) 1/2" P.T. Delivery Port (1) 1/2" P.T.

### SC-3 CHECK VALVE



<b>FortproUSA#:</b> F224654
<b>Replaces:</b> 227871, 800372 1676699C1
<b>Notes:</b> Supply Port (1) 1/2" P.T. Delivery Port (1) 1/2" P.T.

### DC-4 DOUBLE CHECK VALVE



<b>FortproUSA#:</b> F224745
<b>Replaces:</b> 289296, KN25080 20QE2199, 278598
<b>Notes:</b> Male Port (1) 3/8" P.T. Female Ports (1) 1/4" P.T., (2) 3/8" P.T.

### DC-4 DOUBLE CHECK VALVE



<b>FortproUSA#:</b> F224721
<b>Replaces:</b> 280809, 422950C91
<b>Notes:</b> All Ports 3/8" P.T.





## AIR COMPONENTS

### DC-4 DOUBLE CHECK VALVE

**FortproUSA#:** F224714

**Replaces:** 278614, 283321, KN25060  
20QE2222R, 20QE283R, 764368C92

**Notes:** All Ports 3/8" P.T.



### ST-1 SAFETY VALVE

**FortproUSA#:** F224724

**Replaces:** 205105, 1676692C1

**Notes:** All Ports 1/4" P.T.  
150 Psig Cracking Pressure



### ST-3 SAFETY VALVE

**FortproUSA#:** F224652

**Replaces:** 284142, KN31200, 20QE1129, 13943H

**Notes:** 1/4" P.T.  
150 Psig Cracking Pressure



### ST-3 SAFETY VALVE

**FortproUSA#:** F224651

**Replaces:** KN31400, 20QE1282

**Notes:** 1/4" P.T.  
150 Psig Cracking Pressure





## AIR COMPONENTS

### ST-3 SAFETY VALVE



FortproUSA#: **F224649**

Replaces: 284143

Notes: 3/8" P.T.  
150 Psig Cracking Pressure

### ST-4 SAFETY VALVE

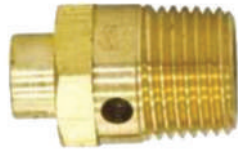

FortproUSA#: **F224601**

Replaces: 131081

Notes: 3/8" P.T.  
250 Psig Cracking Pressure

### AUXILIARY LIFT AXLE VALVE



FortproUSA#: **F224610**

Replaces: 90054079

### CONNECTOR

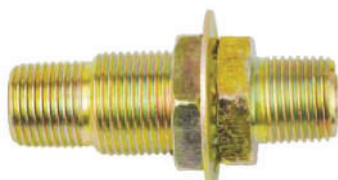

FortproUSA#: **F224624**

Replaces: 217708, FN300







## AIR COMPONENTS

### PUSH PULL KNOB



<b>FortproUSA#:</b> F224742
<b>Replaces:</b> 248433



<b>FortproUSA#:</b> F224743
<b>Replaces:</b> 290655



<b>FortproUSA#:</b> F224761
<b>Replaces:</b> 291041

### PP-1 PUSH PULL VALVE

<b>FortproUSA#:</b> F224616
<b>Replaces:</b> 276566
<b>Notes:</b> All Ports 1/8" P.T. 20 Psig Release



### PP-1 PUSH PULL VALVE

<b>FortproUSA#:</b> F224705
<b>Replaces:</b> 276567, 38597C91
<b>Notes:</b> All Ports 1/8" P.T. 40 Psig Release



### PP-1 PUSH PULL VALVE W/KNOB

<b>FortproUSA#:</b> F224788
<b>Replaces:</b> 284171
<b>Notes:</b> All Ports 1/8" P.T. 40 Psig Release Includes Knob





## AIR COMPONENTS

### PP-7 PUSH PULL VALVE



<b>FortproUSA#:</b> F224715
<b>Replaces:</b> 288239, 20QE3139R, 1693143C1
<b>Notes:</b> Supply Port (1) 1/8" P.T. Delivery Port (1) 1/4" P.T. Control Port (1) 1/8" P.T. 40 Psig Release

### PP-7 PUSH PULL VALVE



<b>FortproUSA#:</b> F224621
<b>Replaces:</b> 288241
<b>Notes:</b> Supply Port (1) 1/8" P.T. Delivery Port (1) 1/4" P.T. Control Port (1) 1/8" P.T. Exhaust (1) 1/4" P.T. 40 Psig Release

### PUSH PULL VALVE



<b>FortproUSA#:</b> F224619
<b>Replaces:</b> KN20031
<b>Notes:</b> All Ports 1/4" P.T. 25-35 Psig Release

### QR-L QUICK RELEASE VALVE



<b>FortproUSA#:</b> F224602
<b>Replaces:</b> 800333
<b>Notes:</b> Male Pipe Stud 1/2" P.T. Female Port 1/2" P.T.





## AIR COMPONENTS



FortProUSA#	Type	Replaces	Notes
<b>F224789</b>	MV-3	20QE3316M, KN20603, 800522	Auxiliary Port 1/8" P.T. All other Port 1/4" P.T
<b>F224611</b>	MV-3	800257	3/8" Pushlock
<b>F224612</b>	MV-3	800259	3/8" Pushlock 1/4" - 20 Thread
<b>F224613</b>	MV-3	800516	All Port 1/4" P.T.
<b>F224614</b>	MV-3	20QE3374, 800445	All Port 1/4" P.T.
<b>F224615</b>	MV-2	KN20615	6 Port 1/4" P.T.

### LEVELING VALVE

<b>FortproUSA#: F245604</b>
<b>Replaces:</b> 20QE3345
<b>Notes:</b> All Ports 1/4" P.T.



### HEIGHT CONTROL VALVE

<b>FortproUSA#: F245606</b>
<b>Replaces:</b> 4640070040





## AIR COMPONENTS

### HEIGHT CONTROL VALVE



FortproUSA#: **F245563**

Replaces: H00600P

### HEIGHT CONTROL VALVE



FortproUSA#: **F245564**

Replaces: H00500C

### ADJUSTABLE LINKAGE



FortproUSA#: **F245613**

Replaces: 48100367

FortproUSA#: **F245614**

Replaces: 48100225

### HEIGHT CONTROL VALVE

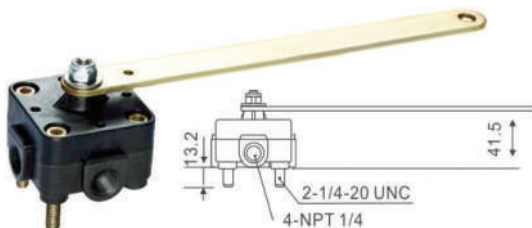

FortproUSA#: **F245607**

Replaces: 171.H101, KD2204





## AIR COMPONENTS

### HEIGHT CONTROL VALVE

FortproUSA#: **F245608**

Replaces: 171.H103, KD2261

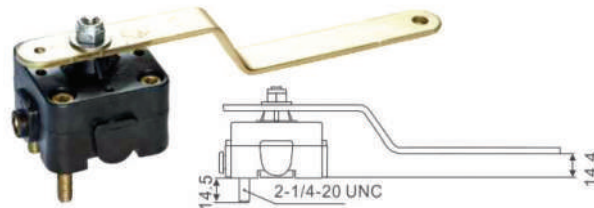

### HEIGHT CONTROL VALVE

FortproUSA#: **F245609**

Replaces: 171.H104, KD2262

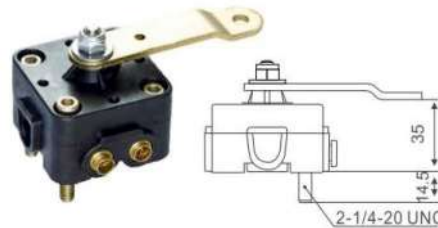

### HEIGHT CONTROL VALVE

FortproUSA#: **F245565**

Replaces: 90555375

Notes: 7" Adjustable Arm 3 Port  
3/8" PTC Side Manifold  
Normally Open Dump



### HEIGHT CONTROL VALVE

FortproUSA#: **F245566**

Replaces: 90554950

Notes: 7" Adjustable Arm With Normally Open  
Dump, 3 Port 1/4" NPT Straight Manifold,  
For Truck and Tractor Axle Applications





## AIR COMPONENTS

### LEVELING VALVE



FortproUSA#: **F245603**

Replaces: HDKVS227

Notes: All Ports 1/4" P.T.

### LEVELING VALVE



FortproUSA#: **F204401**

Replaces: 90054007

Notes: All Ports 1/8" P.T.

### LEVELING VALVE

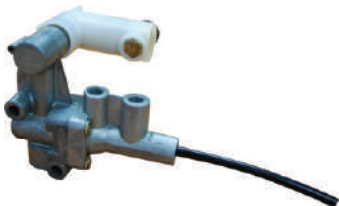

FortproUSA#: **F245601**

Replaces: 20QE3126

Notes: All Ports 1/8" P.T.

### LEVELING VALVE



FortproUSA#: **F245602**

Replaces: KN27000

Notes: All Ports 1/4" P.T.





## AIR COMPONENTS

### LEVELING VALVE

FortproUSA#: **F245605**

Replaces: 60501000

Notes: All Ports 1/4" P.T.



### AIR HORN VALVE

FortproUSA#: **F224900**

Replaces: 86RD13A, 228928



### AIR HORN VALVE

FortproUSA#: **F224899**

Replaces: 86RD16A, 228431



### AIR HORN VALVE

FortproUSA#: **F224901**

Replaces: 20QE29317





## AIR COMPONENTS

### FOUR CIRCUIT PROTECTION VALVE



FortproUSA#: **F224784**

Replaces: AE4170

Notes: European Application

### SEAT CONTROL VALVE



FortproUSA#: **F245625**

Replaces: 800-6222077001

Notes: Seat Height Control  
Valve Kit

### SEAT CONTROL VALVE

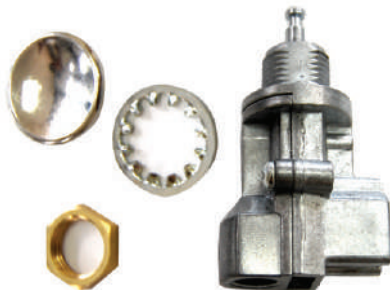

FortproUSA#: **F245626**

Replaces: 9538-1343

Notes: All Ports 1/8" P.T.





## AIR COMPONENTS

### AIR SOLENOID VALVE

FortproUSA#: **F224902**

Replaces: 20QE3373

Notes: All Ports 1/8" P.T. Mack Application



### AIR SOLENOID VALVE

FortproUSA#: **F224903**

Replaces: 1689785C91

Notes: All Ports 1/8" P.T. International Application



### AIR SOLENOID VALVE

FortproUSA#: **F224904**

Replaces: A06-26631-000

Notes: All Ports 1/8" P.T. Freightliner Application





6300 NW 84 AVE  
MIAMI, FL 33166 - USA

## Heavy Duty Truck & Trailer Parts

# AIR COMPONENTS

### AIR SPRING SEAT KIT



FortproUSA#: **F245579**

Replaces: 800-6222086001

### TW-1 CONTROL VALVE



FortproUSA#: **F224747**

Replaces: 229635, 14651, 233699R91

Notes: All Ports 1/8" P.T.

### TRANSMISSION RANGE VALVE



FortproUSA#: **F112864**

Replaces: A-3546, 20QE2116, 265211C94

Notes: All Ports (1) 1/8" P.T.

### TRANSMISSION SELECTOR VALVE



FortproUSA#: **F112900**

Replaces: A-6909

Notes: All Ports 1/16" P.T.





## AIR COMPONENTS

### TRANSMISSION SELECTOR VALVE ■

<b>FortproUSA#: F112901</b>
<b>Replaces:</b> A-6913
<b>Notes:</b> All Ports 1/16" P.T.



### TRANSMISSION SELECTOR VALVE ■

<b>FortproUSA#: F112902</b>
<b>Replaces:</b> A-6915
<b>Notes:</b> All Ports 1/16" P.T.



### TRANSMISSION SELECTOR VALVE ■

<b>FortproUSA#: F112903</b>
<b>Replaces:</b> A-6918
<b>Notes:</b> All Ports 1/16" P.T.



### TRANSMISSION SELECTOR VALVE ■

<b>FortproUSA#: F112904</b>
<b>Replaces:</b> A-6910
<b>Notes:</b> All Ports 1/16" P.T.





## AIR COMPONENTS

### TRANSMISSION SELECTOR VALVE



FortproUSA#: **F123240**

Replaces: 20QE398

Notes: All Ports 1/16" P.T.

### TRANSMISSION SELECTOR VALVE



FortproUSA#: **F112920**

Replaces: A-4487

Notes: All Ports 1/16" P.T.

### T2070 / T2080 SELECTOR VALVE



FortproUSA#: **F123245**

Replaces: 20QE3333

Notes: 4 Ports 3/16" Tube

### T2090 / T2100 SELECTOR VALVE



FortproUSA#: **F123246**

Replaces: 20QE3334A

Notes: 3 Ports 3/16" Tube



## AIR COMPONENTS

### T2130 SELECTOR VALVE

FortproUSA#: **F123247**

Replaces: 20QE3335A

Notes: 4 Ports 3/16" Tube



### T2180 SELECTOR VALVE

FortproUSA#: **F123248**

Replaces: 20QE3336

Notes: 4 Ports 3/16" Tube



### SLAVE VALVE / FULLER TRANSMISSION

FortproUSA#: **F112803**

Replaces: A-4688, 422159C92

Notes: All Ports 1/8" P.T.



### SLAVE VALVE / FULLER TRANSMISSION

FortproUSA#: **F112805**

Replaces: 216KD41

Notes: All Ports 1/8" P.T.





## AIR COMPONENTS

### SLAVE VALVE / FULLER TRANSMISSION



FortproUSA#: **F112804**

Replaces: A-5000

Notes: All Ports 1/8" P.T.

### SLAVE VALVE / MACK TRANSMISSION



FortproUSA#: **F123230**

Replaces: 216KD42B

Notes: All Ports 1/8" P.T.

### VALVE INSERT



FortproUSA#: **F112810**

Replaces: 19974, 363048C91

### PRESSURE REGULATOR



FortproUSA#: **F112802**

Replaces: 16743, 464688C91

Notes: Supply Port (1) 1/4" P.T.  
Delivery Port (1) 1/8" P.T.



## AIR COMPONENTS

### REGULATOR FILTER ASSEMBLY

FortproUSA#: **F112801**

Replaces: A-4740

Notes: All Ports 1/8" P.T.



### SPRING BRAKE CONTROL VALVE

FortproUSA#: **F224603**

Replaces: 110500

Notes: Spring Brake Priority



### GLADHAND - UNIVERSAL

FortproUSA#: **F224759**

Replaces: 275150

Notes: Universal





## Heavy Duty Truck & Trailer Parts

# AIR COMPONENTS

### GLADHAND



<b>FortproUSA#:</b> F224722
<b>Replaces:</b> 278524, 59QE124
<b>Notes:</b> Emergency, Red

<b>FortproUSA#:</b> F224723
<b>Replaces:</b> 278523, 59QE123
<b>Notes:</b> Service, Blue

### GLADHAND



<b>FortproUSA#:</b> F224763
<b>Replaces:</b> 12338
<b>Notes:</b> Emergency, Red

<b>FortproUSA#:</b> F224764
<b>Replaces:</b> 12336
<b>Notes:</b> Service, Blue

### GLADHAND



<b>FortproUSA#:</b> F224827
<b>Replaces:</b> 12138
<b>Notes:</b> Emergency, Red

<b>FortproUSA#:</b> F224828
<b>Replaces:</b> 12136
<b>Notes:</b> Service, Blue

### GLADHAND GRIP

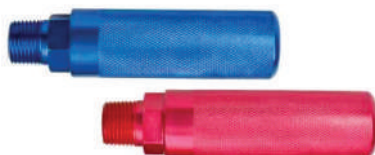

<b>FortproUSA#:</b> F224765
<b>Replaces:</b> 12600







## Heavy Duty Truck & Trailer Parts

# AIR COMPONENTS

### SEAL, HOSE COUPLER

FortproUSA#: <b>F224760</b>
Replaces: 248579, 126SK11
FortproUSA#: <b>F224760B</b>
Replaces: 10028 (Blue)
FortproUSA#: <b>F224760R</b>
Replaces: 10028 (Red)



### AIR HOSE WITH GUN

FortproUSA#: <b>F224628</b>
Replaces: 63050
Notes: Air Cab Blow Gun Kit



### AIR HOSE SET

FortproUSA#: <b>F224748</b>
Replaces: 73151612
Notes: 15 Ft. Working Length



### HOSE SUPPORT SPRING

FortproUSA#: <b>F224829</b>
Replaces: 11600
Notes: O.D. 1-1/18" Length 25"
FortproUSA#: <b>F224835</b>
Replaces: 11602
Notes: O.D. 1" Length 12"





## AIR COMPONENTS

### HOLDER



FortproUSA#: **F224648**

Replaces: 59QE33

### 3 IN 1 AIR BRAKE & ABS CABLE



FortproUSA#: **F235507**

Replaces: 42045656, 451098, 169157

Notes: ABS 15 Feet working length, 7 way

### HOSE TENDER (CHROME FINISH)



FortproUSA#: **F245551**

Replaces: 9400G-2

Notes: Includes the Clamp





## AIR COMPONENTS

### AIR BRAKE HOSE ASSEMBLY

FortProUSA#	Head Size 3/8" & 3/8"	Ref. Tectran
<b>F229080</b>	16118-66	21034
<b>F229081</b>	16120-66	21042
<b>F229082</b>	16124-66	21051
<b>F229083</b>	16126-66	21056
<b>F229084</b>	16128-66	21061
<b>F229085</b>	16130-66	21065
<b>F229086</b>	16132-66	21069
<b>F229087</b>	16136-66	21079
<b>F229088</b>	16140-66	21087
<b>F229089</b>	16148-66	21104
<b>F229090</b>	16160-66	21111
<b>F229091</b>	16160-66	21118
<b>F229092</b>	16172-66	21135



### NYLON TUBING

FortProUSA#	Description	O.D.	Length
<b>F225080-100</b>	Nylon Tubing	1/8"	100'
<b>F225081-100</b>	Nylon Tubing	5/32"	100'
<b>F225082-100</b>	Nylon Tubing	3/16"	100'
<b>F225083-100</b>	Nylon Tubing	1/4"	100'
<b>F225084-100</b>	Nylon Tubing	5/16"	100'
<b>F225085-100</b>	Nylon Tubing	3/8"	100'
<b>F225086-100</b>	Nylon Tubing	1/2"	100'
<b>F225087-100</b>	Nylon Tubing	5/8"	100'
<b>F225088-100</b>	Nylon Tubing	3/4"	50'





Heavy Duty Truck & Trailer Parts

**AIR COMPONENTS**

**UNION**



FortProUSA#	Part No.	Ref. Tectran	Tube Size
<b>F229021</b>	1362-4	85016	1/4
<b>F229022</b>	1362-6	85017	3/8
<b>F229023</b>	1362-8	85018	1/2
<b>F229024</b>	1362-10	85014	5/8
<b>F229025</b>	1362-12	85015	3/4

**MALE CONNECTOR**



FortProUSA#	Part No.	Ref. Tectran	Tube Size	Pipe Thread
<b>F229026</b>	1368-4A	85049	1/4	1/8
<b>F229027</b>	1368-4B	85050	1/4	1/4
<b>F229028</b>	1368-4C	85051	1/4	3/8
<b>F229029</b>	1368-6A	85052	3/8	1/8
<b>F229030</b>	1368-6B	85053	3/8	1/4
<b>F229031</b>	1368-6C	85054	3/8	3/8
<b>F229032</b>	1368-6D	85055	3/8	1/2
<b>F229033</b>	1368-8B	85056	1/2	1/4
<b>F229034</b>	1368-8C	85057	1/2	3/8
<b>F229035</b>	1368-8D	85058	1/2	1/2





Heavy Duty Truck & Trailer Parts

**AIR COMPONENTS**

**MALE ELBOW**

FortProUSA#	Part No.	Ref. Tectran	Tube Size	Pipe Thread
<b>F229036</b>	1369-4A	85068	1/4	1/8
<b>F229037</b>	1369-4B	85069	1/4	1/4
<b>F229038</b>	1369-4C	85070	1/4	3/8
<b>F229039</b>	1369-6A	85071	3/8	1/8
<b>F229040</b>	1369-6B	85072	3/8	1/4
<b>F229041</b>	1369-6C	85073	3/8	3/8
<b>F229042</b>	1369-6D	85174	3/8	1/2
<b>F229043</b>	1369-8B	85075	1/2	1/4
<b>F229044</b>	1369-8C	85076	1/2	3/8
<b>F229045</b>	1369-8D	85077	1/2	1/2
<b>F229046</b>	1369-10C	85063	5/8	3/8
<b>F229047</b>	1369-10D	85064	5/8	1/2
<b>F229048</b>	1369-10E	85065	5/8	3/4
<b>F229049</b>	1369-12D	85066	3/4	1/2
<b>F229050</b>	1369-12E	85067	3/4	3/4



**MALE RUN TREE**

FortProUSA#	Part No.	Ref. Tectran	Tube Size	Pipe Thread
<b>F229051</b>	1371-4A	85087	1/4	1/8
<b>F229052</b>	1371-4B	85088	1/4	1/4
<b>F229053</b>	1371-6B	85089	3/8	1/4
<b>F229054</b>	1371-6C	85090	3/8	3/8
<b>F229055</b>	1371-8C	85091	1/2	3/8
<b>F229056</b>	1371-8D	85092	1/2	1/2
<b>F229057</b>	1371-10D	85086	5/8	1/2





## AIR COMPONENTS

### MALE RUN TREE



FortProUSA#	Part No.	Ref. Tectran	Tube Size	Pipe Thread
<b>F229058</b>	1372-4A	85094	1/4	1/8
<b>F229059</b>	1372-4B	85095	1/4	1/4
<b>F229060</b>	1372-6A	85096	3/8	1/8
<b>F229061</b>	1372-6B	85097	3/8	1/4
<b>F229062</b>	1372-6C	85098	3/8	3/8
<b>F229063</b>	1372-8C	85099	1/2	3/8
<b>F229064</b>	1372-8D	85100	1/2	1/2
<b>F229065</b>	1372-10D	85093	5/8	1/2

### 45° ELBOW



FortProUSA#	Part No.	Ref. Tectran	Tube Size	Pipe Thread
<b>F229066</b>	1374-4A	85102	1/4	1/8
<b>F229067</b>	1374-4B	85103	1/4	1/4
<b>F229068</b>	1374-6A	85104	3/8	1/8
<b>F229069</b>	1374-6B	85105	3/8	1/4
<b>F229070</b>	1374-6C	85106	3/8	3/8
<b>F229071</b>	1374-6D	85107	3/8	1/2
<b>F229072</b>	1374-8B	85108	1/2	1/4
<b>F229073</b>	1374-8C	85109	1/2	3/8
<b>F229074</b>	1374-8D	85110	1/2	1/2
<b>F229075</b>	1374-10D	85101	5/8	1/2





## AIR COMPONENTS

### TU-FLO 550 / 750

FortproUSA#: **F224887**

Replaces: 107510

Notes: Mack E6 & E7



### TU-FLO 750

FortproUSA#: **F224888**

Replaces: 109429

Notes: Detroit



### TU-FLO 550 / 750

FortproUSA#: **F224889**

Replaces: 109088

Notes: CAT & INTER





6300 NW 84 AVE  
MIAMI, FL 33166 - USA

## Heavy Duty Truck & Trailer Parts

# AIR COMPONENTS - Tu-Flo 500/700 Compressor Parts

### RING SET FOR 2 PISTONS

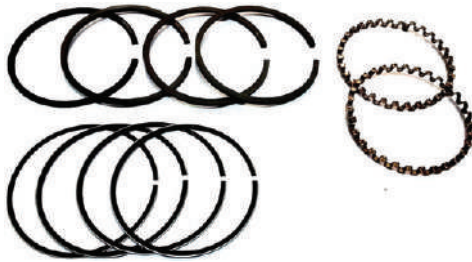

FortProUSA#	Replaces	Notes
F224863-STD	225514	Tu-Flo 500
F224863-010	225515	Tu-Flo 500
F224863-020	225516	Tu-Flo 500
F224863-030	225517	Tu-Flo 500
F224865-STD	282525	Tu-Flo 700
F224865-010	282526	Tu-Flo 700
F224865-020	282527	Tu-Flo 700
F224865-030	282528	Tu-Flo 700

### PISTON KIT



FortProUSA#	Replaces	Notes
F224864-STD	289928	Tu-Flo 500
F224864-010	289929	Tu-Flo 500
F224864-020	289930	Tu-Flo 500
F224864-030	289931	Tu-Flo 500
F224866-STD	289891	Tu-Flo 700
F224866-010	289892	Tu-Flo 700
F224866-020	289893	Tu-Flo 700
F224866-030	289894	Tu-Flo 700

### CONNECTING ROD BEARINGS



FortProUSA#	Replaces	Notes
F224867-STD	282767	Tu-Flo 500/700
F224867-010	282768	Tu-Flo 500/700
F224867-020	282769	Tu-Flo 500/700
F224867-030	282770	Tu-Flo 500/700

### MAINTENANCE KIT



FortProUSA#	Replaces	Notes
F224881	229417	Tu-Flo 500/700





## AIR COMPONENTS - Tu-Flo 501 Compressor Parts

### RING SET FOR 2 PISTONS

FortProUSA#	Replaces	Notes
F224869-STD	286183	For 3 Rings Piston
F224869-010	286184	For 3 Rings Piston
F224869-020	286185	For 3 Rings Piston
F224869-030	286186	For 3 Rings Piston
<i>* For 5 Rings Piston Used 2 sets</i>		

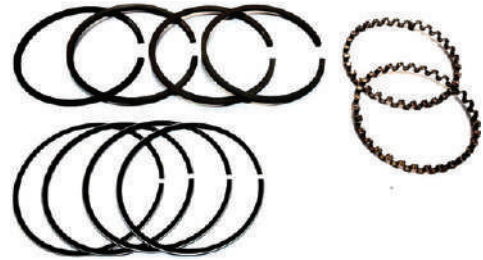

### PISTON KIT

FortProUSA#	Replaces	Notes
F224872-STD	282110	3 Rings (Iron)
F224872-010	282111	3 Rings (Iron)
F224872-020	282112	3 Rings (Iron)
F224872-030	282113	3 Rings (Iron)
F224873-STD	289113	5 Rings (Alum)
F224873-010	289114	5 Rings (Alum)
F224873-020	289115	5 Rings (Alum)
F224873-030	289116	5 Rings (Alum)



### CONNECTING ROD BEARINGS

FortProUSA#	Replaces	Notes
F224875-STD	286254	
F224875-010	286255	
F224875-020	286256	
F224875-030	286257	



### MAINTENANCE KIT MAINTENANCE KIT

FortProUSA#	Replaces	Notes
F224883	287043, 637488C91	





Heavy Duty Truck & Trailer Parts

**AIR COMPONENTS - Tu-Flo 550/750 Compressor Parts**

**RING SET FOR 2 PISTONS**

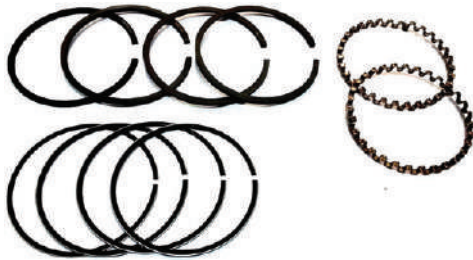

FortProUSA#	Replaces	Notes
F224876-STD	107639	550/750
F224876-010	107640	550/750
F224876-020	107641	550/750
F224876-030	107642	550/750

**PISTON KIT**



FortProUSA#	Replaces	Notes
F224877-STD	107647	550
F224877-010	107648	550
F224877-020	107649	550
F224877-030	107650	550
F224878-STD	107643	750
F224878-010	107644	750
F224878-020	107645	750
F224878-030	107646	750

**CONNECTING ROD BEARINGS**



FortProUSA#	Replaces	Notes
F224879-STD	107651	550/750
F224879-010	107652	550/750
F224879-020	107653	550/750
F224879-030	107654	550/750

**MAINTENANCE KIT**

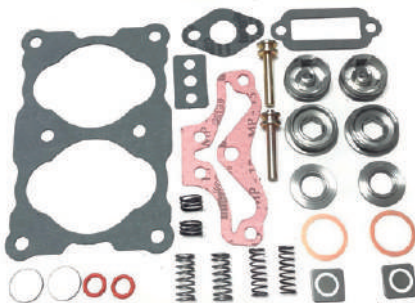

FortProUSA#	Replaces	Notes
F224885	107516	550/750





## AIR COMPONENTS - Midland 1300 Compressor Parts

### RING SET FOR 2 PISTONS

FortProUSA#	Replaces	Notes
F224890-STD	RN26ED	
F224890-010	N/A	
F224890-020	RN26EF	
F224890-030	N/A	



### PISTON KIT

FortProUSA#	Replaces	Notes
F224891-STD	200923A	
F224891-010	200923B	
F224891-020	200923C	
F224891-030	N/A	



### CONNECTING ROD BEARINGS

FortProUSA#	Replaces	Notes
F224892-STD	RN26EG	
F224892-010	RN26EH	
F224892-020	RN26EJ	



### MAINTENANCE KIT

FortProUSA#	Replaces	Notes
F224893	RNT26	





# UNIVERSAL JOINTS

\* Hardware Included

## BEARING PLATE STYLE

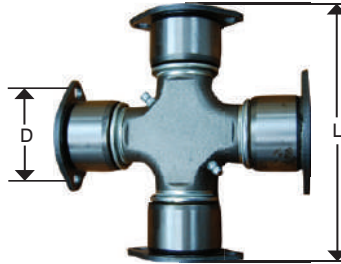

FortProUSA#	Replaces	Series	L x D
<b>F276112</b>	5-279X	1610	5.312" x 1.875"
<b>F276113</b>	5-280X	1710	6.094" x 1.938"
<b>F276117</b>	5-407X	1760	7.000" x 1.938"
<b>F276114</b>	5-281X	1810	7.547" x 1.938"

## HALF ROUND STYLE

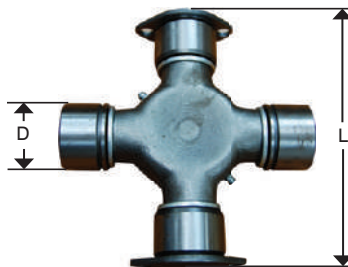

FortProUSA#	Replaces	Series	L x D
<b>F276122</b>	5-674X, 5-438X	1610	5.312" x 1.875"
<b>F276120</b>	5-515X	1710	6.094" x 1.938"
<b>F276126</b>	5-675X, 5-515X	1710	6.094" x 1.938"
<b>F276118</b>	5-469X	1760	7.000" x 1.938"
<b>F276125</b>	5-677X, 5-469X	1760	7.000" x 1.938"
<b>F276119</b>	5-510X	1810	7.547" x 1.938"
<b>F276124</b>	5-676X, 5-510X	1810	7.547" x 1.938"





# UNIVERSAL JOINTS

\* Hardware Included

## BEARING PLATE / WING BEARING STYLE

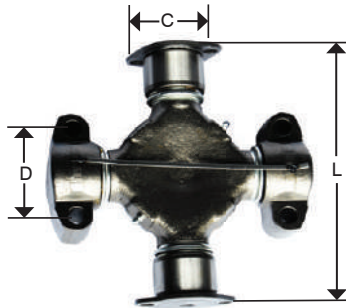

FortProUSA#	Replaces	Series	L x D x C
<b>F276115</b>	5-324X	1810	7.547" x 2.812" x 1.938"
<b>F276116</b>	5-326X	1880	8.094" x 2.812" x 2.188"

## WING BEARING STYLE

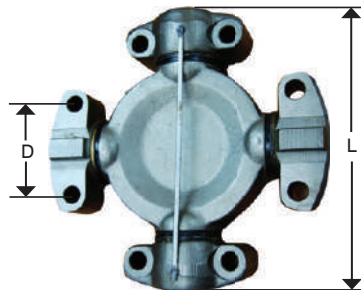

FortProUSA#	Replaces	Series	L x D
<b>F276121</b>	5-6106X	6C / 62N	5.531" x 1.688"
<b>F276123</b>	5-9016X, 5-9001X	9C / 92N	8.250" x 2.812"





# UNIVERSAL JOINTS

## OUTSIDE SNAP RING STYLE

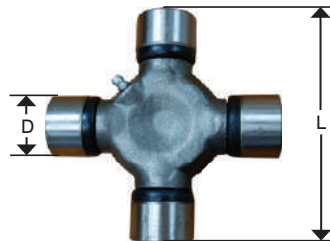

FortProUSA#	Replaces	Series	L x D
<b>F276129</b>	5-153X	1310	3.219" x 1.062"
<b>F276105</b>	5-160X	1410	4.188" x 1.188"
<b>F276110</b>	5-155X	1550	4.964" x 1.375"

## INSIDE SNAP RING STYLE



FortProUSA#	Replaces	Series	L x D
<b>F276111</b>	5-170X, 5-103X	1000	2.080" x 0.938"



# UNIVERSAL JOINTS

## SPL TYPE

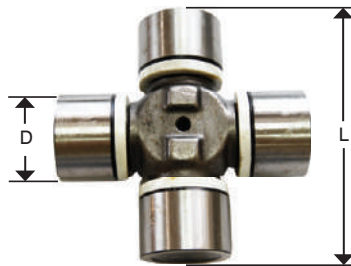

FortProUSA#	Replaces	Series	L x D
<b>F276106</b>	SPL90X	SPL	4.960" x 1.625"
<b>F276107</b>	SPL140X	SPL	5.461" x 1.937"
<b>F276108</b>	SPL170X	SPL	6.465" x 2.165"
<b>F276109</b>	SPL250X	SPL	6.417" x 2.362"

## RPL TYPE

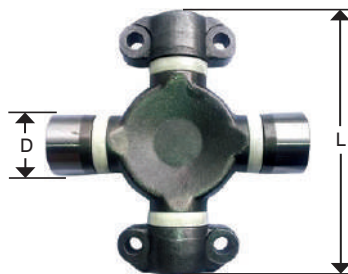

FortProUSA#	Replaces	Series	L x D
<b>F276127</b>	CP20RPL-1	RPL	6.88" x 2.81"
<b>F276128</b>	CP25RPL-1	RPL	8.20" x 2.81"





# UNIVERSAL JOINTS HARDWARE



FortProUSA#	Replaces	Notes
<b>F276201</b>	37038X	Kit Strap 1480 / 1550 Series
<b>F276202</b>	57028X	Kit Strap 1610 Series
<b>F276203</b>	657018X	Kit Strap 1710 / 1760 / 1810 Series
<b>F276204</b>	170-70-18X	Kit Retainer SPL170
<b>F276205</b>	250-70-18X	Kit Retainer SPL250
<b>F276206</b>	98741	Lock Plates used on 5-279X
<b>F276207</b>	48RU1903	Lock Plates used on 5-280X & 5-281X





# CENTER SUPPORT BEARINGS

## CENTER BEARING

<b>FortproUSA#:</b> F276101
<b>Replaces:</b> 210661-1X, HB88512A
<b>Notes:</b> Bearing ID 60 mm, 2.362", 1800/1810 Series



## CENTER BEARING POLYURETHANE

<b>FortproUSA#:</b> F276101P
<b>Replaces:</b> 210661-1X, HB88512A
<b>Notes:</b> Bearing ID 60 mm, 2.362", 1800/1810 Series, Polyurethane



## CENTER BEARING

<b>FortproUSA#:</b> F276102
<b>Replaces:</b> 210121-1X, HB88510
<b>Notes:</b> Bearing ID 50 mm, 1.968", 1700/1710 Series



## CENTER BEARING

<b>FortproUSA#:</b> F276103
<b>Replaces:</b> 210084-2X, HB88509
<b>Notes:</b> Bearing ID 45 mm, 1.177", 1650 Series



## CENTER BEARING

<b>FortproUSA#:</b> F276104
<b>Replaces:</b> 210391-1X, HB88508
<b>Notes:</b> Bearing ID 40 mm, 1.574", 1410 Series





## Heavy Duty Truck & Trailer Parts

# BEARINGS



FortProUSA#	Replaces	Description
F276175	Set 68 (497 / 493)	Cone / Cup Set
F276152	Set 401 (580 / 572)	Cone / Cup Set
F276155	Set 402 (582 / 572)	Cone / Cup Set
F276157	Set 403 (594A / 592A)	Cone / Cup Set
F276158	Set 404 (598A / 592A)	Cone / Cup Set
F276160	Set 405 (663 / 653)	Cone / Cup Set
F276161	Set 406 (3782 / 3720)	Cone / Cup Set
F276164	Set 407 (28682 / 28622)	Cone / Cup Set
F276167	Set 408 (39590 / 39520)	Cone / Cup Set
F276170	Set 409 (45280 / 45220)	Cone / Cup Set
F276173	Set 410 (45284 / 45220)	Cone / Cup Set
F276176	Set 411 (47686 / 47620)	Cone / Cup Set
F276179	Set 412 (HM212047 / HM212011)	Cone / Cup Set
F276149	Set 413 (HM212049 / HM212011)	Cone / Cup Set
F276272	Set 414 (HM218248 / HM218210)	Cone / Cup Set
F276273	Set 415 (HM518445 / HM518410)	Cone / Cup Set
F276274	Set 420 (HM715345 / H715311)	Cone / Cup Set
F276277	Set 421 (HM516449A / HM516410)	Cone / Cup Set
F276280	Set 422 (HM516449C / HM516410)	Cone / Cup Set
F276282	Set 423 (6461A / 6420)	Cone / Cup Set
F276285	Set 424 (555-S / 552A)	Cone / Cup Set
F276288	Set 425 (567 / 563)	Cone / Cup Set
F276291	Set 426 (47679 / 47620)	Cone / Cup Set
F276145	740 / 742	Cone / Cup Set
F276146	759 / 752	Cone / Cup Set
F276147	6306 - 2RSNR	Bearing, Pilot





Heavy Duty Truck & Trailer Parts

**OIL SEALS**



FortProUSA#	Replaces	Description
F276225	370001A / 32QJ19301 / 359917C91	Oil Seal
F276226	370003A / 32QJ19353	Oil Seal
F276227	370005A	Oil Seal
F276228	370019A / 88AX427 / 296394C91	Oil Seal
F276237	370021A	Oil Seal
F276229	370022A / 88AX467 / 1676354C1	Oil Seal
F276230	370023 / 88AX439 / 1654330C1	Oil Seal
F276231	370025A	Oil Seal
F276232	370028A / 88AX378 / 111908R91	Oil Seal
F276233	370031A / 88AX418	Oil Seal
F276238	370036A	Oil Seal
F276239	370037A	Oil Seal
F276234	370048A / 88AX469	Oil Seal
F276235	370065A	Oil Seal
F276236	370069A / 88AX424	Oil Seal
F276220	32QJ225 / 370033A / 320-2039	Oil Seal
F276222	6638 - S	Oil Seal
F276240	25024	Oil Seal
F276243	370124A	Oil Seal
F276244	370131A	Oil Seal
F276245	370150A	Oil Seal
F276246	376590A	Oil Seal
F276223	Seal Front Axle Isuzu	Oil Seal
F276224	0962559 / GM-97715989	Rear Axle Isuzu
F276221	370031 / Kit Seal & Wear Ring	Oil Seal
F174055	88AX449 Seal Trunnion	44,000 Lbs
F174065	88AX253 Seal Trunnion	55,000 Lbs





## OIL SEALS



FortProUSA#	Replaces	Description
F276208	416414 / 415991 / 415146N / 88AX440P4 / 478864C1	Oil Seal
F276209	415322N / 417484 / 88AX319P2	Oil Seal
F276210	415272N / 88AX354P2	Oil Seal
F276216	455018 / 88AX248BP2	Oil Seal
F276217	415156N / 88AX361P2	Oil Seal
F010045	415563 / 446GC316 (E6)	Front Oil Seal
F010047	2297V / 446GC238B (E7)	Rear Oil Seal
F010048	5645 / 57GC186A (E6)	Rear Oil Seal
F020440	3006736 / 39703 (855, N14)	Front Oil Seal
F020441	3006737 (855, N14)	Rear Oil Seal
F020442	3004316 (855, N14)	Front Oil Seal
F020620	3904353 (4B)	Front Oil Seal
F020621	3909410 (4B, 6B, 6C, ISC, ISB)	Rear Oil Seal
F020622	3353977 (6C & ISC)	Front Oil Seal
F112850	415983N / 19109 / 596144C2	Oil Seal
F123220	2822V / 88AX454 / 88AX400	Oil Seal
F123221	415027N / 88AX391P2 / 478867C1	Oil Seal
F224836	1233	Oil Seal
F224837	7603	Oil Seal
F276240	25024	Seal Grease A26
F276241	H802	Seal Grease A21
F276242	H801	Seal Grease A17



## HUBCAPS

**FortproUSA#: F276183**

**Replaces:** 343-4249

**Notes:** Bolt Circle 5-1/2"  
Holes 6"  
Height 1-13/16"  
Diameter 6-3/16"



**FortproUSA#: F276188**

**Replaces:** 343-4098

**Notes:** Bolt Circle 5-1/2"  
Holes 6"  
Height 1-1/4"  
Diameter 6-3/16"



**FortproUSA#: F276181**

**Replaces:** 343-4075

**Notes:** Height 2-5/16"  
Diameter 6-1/4"  
Thread 8



**FortproUSA#: F276186**

**Replaces:** 340-4975

**Notes:** Height 2-3/4"  
Diameter 6-1/4"  
Thread 8





# HUBCAPS

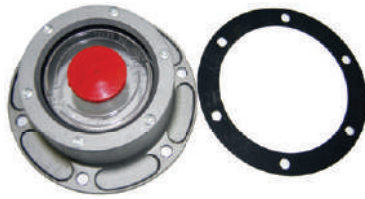

**FortproUSA#:** F276180

**Replaces:** 343-4009

**Notes:** Bolt Circle 5-1/2"  
Holes 6"  
Height 2-11/16"  
Diameter 6-1/4"



**FortproUSA#:** F276187

**Replaces:** 19QJ323, 343-4025

**Notes:** Bolt Circle 5-7/8"  
Holes 6"  
Height 1-3/8"  
Diameter 6-1/2"



**FortproUSA#:** F276182

**Replaces:** 343-4024

**Notes:** Bolt Circle 4-1/2"  
Holes 6"  
Height 2-5/8"  
Diameter 5-1/4"



**FortproUSA#:** F276184

**Replaces:** 343-4013

**Notes:** Bolt Circle 5-1/2"  
Holes 5"  
Height 2-11/16"  
Diameter 6-1/4"





## Heavy Duty Truck & Trailer Parts

# HUBCAPS

### HUBCAP KIT

<b>FortproUSA#:</b> F276185
<b>Replaces:</b> 359-5995
<b>Notes:</b> Used with F276180, F276187



### HUBCAP KIT

<b>FortproUSA#:</b> F276189
<b>Replaces:</b> 359-5912
<b>Notes:</b> Used with F276183, F276188



### HUBCAP PLUG BIG

<b>FortproUSA#:</b> F276190
<b>Replaces:</b> 359-5990
<b>Notes:</b> Included in F276185



### HUBCAP PLUG SMALL

<b>FortproUSA#:</b> F276191
<b>Replaces:</b> 359-5915
<b>Notes:</b> Included in F276189





6300 NW 84 AVE  
MIAMI, FL 33166 - USA

## Heavy Duty Truck & Trailer Parts

# HUBCAPS



FortproUSA#: **F276192**

Replaces: 343-4042

Notes: 6 Holes  
5 11/16" O.D.



FortproUSA#: **F276193**

Replaces: 340-5097

Notes: 6 Holes



FortproUSA#: **F276194**

Replaces: 343-4195





## WHEEL CLAMPS

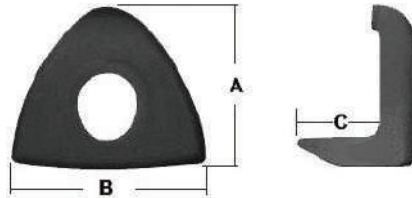

FortProUSA#	Replaces	Height (A)	Width (B)	Reach (C)
<b>F286634</b>	E5040A	2 1/2"	2 7/8"	1 1/2"
<b>F286635</b>	E5572A	2 1/2"	2 7/8"	1 3/4"
<b>F286641</b>	E5783 15QJ223BP6	2 7/16"	2 1/2"	2 3/8"

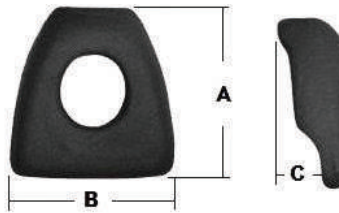

FortProUSA#	Replaces	Height (A)	Width (B)	Reach (C)
<b>F286636</b>	E5890	2 1/8"	2"	1/2"
<b>F286637</b>	E5891	2 1/4"	2"	3/4"

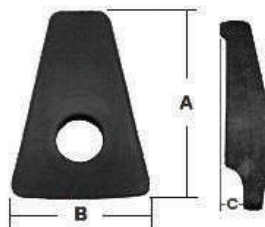

FortProUSA#	Replaces	Height (A)	Width (B)	Reach (C)
<b>F286638</b>	E5902	3 5/8"	2 1/2"	1/2"
<b>F286639</b>	E9024	2 3/4"	2 5/8"	11/32"
<b>F286640</b>	E6053 15QJ251	2 5/8"	2 1/2"	5/16"



## Heavy Duty Truck & Trailer Parts

# WHEELS

### WHEEL CLAMPS



FortProUSA#	Replaces	Height (A)	Width (B)	Reach (C)
<b>F286642</b>	E5883, 15QJ16P3	2 1/2"	6"	1 5/16"
<b>F286643</b>	E5829	2 1/2"	6 5/8"	1 7/16"

### WHEEL NUTS



FortProUSA#	Replaces	Thread	Hex	High
<b>F286651</b>	E4963	3/4" - 10	1 1/4"	23/32"
<b>F286663L</b>	E5652L	3/4" - 16	1 1/2"	7/8"
<b>F286663R</b>	E5652R	3/4" - 16	1 1/2"	7/8"
<b>F286664L</b>	E5977L	1 1/8" - 16	1 1/2"	7/8"
<b>F286664R</b>	E5977R	1 1/8" - 16	1 1/2"	7/8"
<b>F286669</b>	E6000A	M22 x 1.5	33 MM	31 MM





Heavy Duty Truck & Trailer Parts

**WHEEL STUDS**



FortProUSA#	Replaces	Body Dia	Overall Length	Body Length	Thread Length	Serration Length	Thread Size	Note
F286674	4956A	N/A	3"	3"	1" - 1 3/4"	N/A	3/4" - 10	Spoke Wheel Stud
F286677L	E5982L	1.22"	3 3/4"	1 1/4"	2 1/4"	9/16"	1 1/8" - 16	Steer Axle
F286677R	E5982R	1.22"	3 3/4"	1 1/4"	2 1/4"	9/16"	1 1/8" -16	Steer Axle
F286678L	E4967L	0.785	2 7/8"	1 1/2"	1 1/4"	1/2"	3/4" -16	Serrated Drive
F286678R	E4967R	0.785	2 7/8"	1 1/2"	1 1/4"	1/2"	3/4" - 16	Serrated Drive
F286679L	E4968L	0.785	2 7/8"	1 1/2"	1 1/4"	1/2"	3/4" -16	Drum Shoulder
F286679R	E4968R	0.785	2 7/8"	1 1/2"	1 1/4"	1/2"	3/4" - 16	Drum Shoulder
F286680L	E5896L	0.975	3 3/8"	1 3/8"	1 1/4"	1"	3/4" - 16	Serrated Drive
F286680R	E5896R	0.975	3 3/8"	1 3/8"	1 1/4"	1"	3/4" - 16	Serrated Drive
F286681L	E8947L	0.785	2 31/32"	1 3/8"	1 1/16"	1/2"	3/4" - 16	Serrated Drive
F286681R	E8947R	0.785	2 31/32"	1 3/8"	1 1/16"	1/2"	3/4" -16	Serrated Drive
F286682L	E8949L	0.900	2 5/8"	1"	1 1/2"	7/16"	3/4" - 16	Serrated Drive
F286682R	E8949R	0.900	2 5/8"	1"	1 1/2"	7/16"	3/4" - 16	Serrated Drive
F286683L	E8969L	0.785	2 15/16"	1 5/16"	1 13/32"	1/2"	3/4" -16	Serrated Drive
F286683R	E8969R	0.785	2 15/16"	1 5/16"	1 13/32"	1/2"	3/4" - 16	Serrated Drive
F286684L	E8979L	0.785	3 11/32"	1 9/32"	1 27/32"	1/2"	3/4" - 16	Serrated Drive
F286684R	E8979R	0.785	3 11/32"	1 9/32"	1 27/32"	1/2"	3/4" -16	Serrated Drive
F286685L	E9010L	0.975	2 27/32"	13/16"	1 1/8"	1/2"	3/4" -16	Serrated Drive
F286685R	E9010R	0.975	2 27/32"	13/16"	1 1/8"	1/2"	3/4" - 16	Serrated Drive
F286686	E5997	0.900	3 21/32"	7/8"	2 7/16"	13/32"	M22 x 1.5	Serrated Drive Metric
F286687	E6034	0.975	4 25/32"	23/32"	3 17/32"	3/8"	M22 x 1.5	Serrated Drive Metric
F286688	E6035	0.975	3 15/16"	23/32"	2 11/16"	3/8"	M22 x 1.5	Serrated Drive Metric
F286689	E8980	0.975	5 3/32"	7/8"	3 3/4"	1/2"	M22 x 1.5	Serrated Drive Metric
F286690	E8981	0.975	4"	7/8"	2 29/32"	1/2"	M22 x 1.5	Serrated Drive Metric
F286691	E10219	0.910	4 15/32"	1 9/16"	2 9/16"	1/2"	M22 x 1.5	Serrated Drive Metric
F286692	E10221	0.910	5 11/16"	1 9/16"	3 7/16"	1/2"	M22 x 1.5	Serrated Drive Metric
F286693	E10676	0.975	4 1/4"	7/16"	3 1/4"	1/2"	M22 x 1.5	Serrated Drive Metric
F286694	E8986	1.22"	4.52"	1.00"	2.63"	0.44"	M22 X 1.5	Serrated Drive Metric





## Heavy Duty Truck & Trailer Parts

# WHEELS

### INNER CAP NUTS



FortProUSA#	Replaces	Overall Length	Thread O.D.	Thread O.D.	Thread I.D.	Inner Thread Depth
F286653L	E7895L	2 1/4"	1 1/8" - 16	3/4" 16	3/4" - 16	1 1/4"
F286653R	E7895R	2 1/4"	1 1/8" - 16	3/4" 16	3/4" - 16	1 1/4"
F286654L	E7896L	2 9/16"	1 1/8" - 16	3/4" 16	3/4" - 16	1 1/4"
F286654R	E7896R	2 9/16"	1 1/8" - 16	3/4" 16	3/4" - 16	1 1/4"
F286655L	E7897L	3 1/16"	1 1/8" - 16	3/4" 16	3/4" - 16	1 7/8"
F286655R	E7897R	3 1/16"	1 1/8" - 16	3/4" 16	3/4" - 16	1 7/8"
F286656L	E5978L	3 1/16"	1 1/8" - 16	3/4" 16	3/4" - 16	1 15/16"
F286656R	E5978R	3 1/16"	1 1/8" - 16	3/4" 16	3/4" - 16	1 15/16"
F286657L	E5988L	3 1/16"	1 1/8" - 16	3/4" 16	3/4" - 16	1 7/8"
F286657R	E5988R	3 1/16"	1 1/8" - 16	3/4" 16	3/4" - 16	1 7/8"

### WHEEL SLEEVE NUT



FortProUSA#	Description	Replaces
F286666	M22 X 1.5 WHEEL SLEEVE NUT 33MM HEX (6MM) (STEER)	333SN6, 201.3031, GL2900
F286667	M22 X 1.5 WHEEL SLEEVE NUT 33MM HEX (19MM) (DRIVE STEEL/STEEL)	333SN19, 201.3032, GL2919
F286668	WHEEL SLEEVE NUT 33MM HEX (28MM) (DRIVE ALUM OUTER/STEEL INNER)	333SN28, 201.3033, GL2928





## Heavy Duty Truck & Trailer Parts

# WHEELS

### ALUMINUM WHEELS

FortproUSA#: **F286440**

**Notes:** 22.5"x 8.25" Hub-Pilot, 10 Bolts, 10 Hand Holes, Aluminum, Machined Finish

FortproUSA#: **F286441**

**Notes:** 24.5"x 8.25" Hub-Pilot, 10 Bolts, 10 Hand Holes, Aluminum, Machined Finish



### TUBELESS STEEL WHEELS

FortproUSA#: **F286436**

**Notes:** 22.5"x 8.25" Hub-Pilot, 10 Bolts, 2 Hand Holes, American Type



### TUBELESS STEEL WHEELS

FortproUSA#: **F286435**

**Notes:** 22.5"x 8.25" Stud-Piloted, 10 Bolts, 2 Hand Holes, American Type



### TUBELESS STEEL WHEELS

FortproUSA#: **F286432**

**Notes:** 22.5"x 9" Hub-Pilot, 10 Bolts, 10 Hand Holes, American Type



### TUBELESS STEEL WHEELS

FortproUSA#: **F286430**

**Notes:** 22.5"x 8.25" Demountable Rim

FortproUSA#: **F286437**

**Notes:** 24.5"x 8.25" Demountable Rim



### TUBELESS STEEL WHEELS

FortproUSA#: **F286433**

**Notes:** 24.5"x 8.25" Hub-Pilot, 10 Bolts, 2 Hand Holes, American Type





## Heavy Duty Truck & Trailer Parts

# LANDING GEAR - 5TH WHEELS & PARTS

### LANDING GEAR

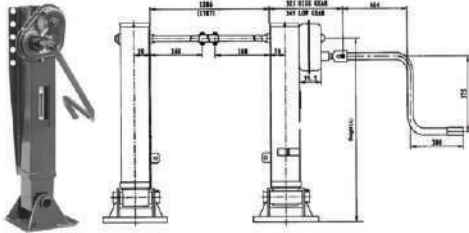

**FortproUSA#: F286425**

- Landing Gear Set
- Static Load Capacity - 170,000 Lbs
- Lifting Capacity - 60,000 Lbs
- Hardware Included for set Part Number
- Universal Mounting
- Comparable to KIC and Holland / Brinkley 50,000

### SAF-HOLLAND LANDING GEAR ASSEMBLY



**PART#: LGS-3A105**

- HOLLAND MARK V Series 17" Travel
- LIFT CAPACITY: 62,500 lbs. at 100 ft.-lbs. input torque
- ULTIMATE LOAD CAPACITY: 200,000 lbs.
- SIDE-LOAD CAPACITY: 32,000 lbs.

### SAF-HOLLAND LANDING GEAR ASSEMBLY



**PART#: LG4001-70000000**

- HOLLAND ATLAS 55 Series 17" Travel
- LIFT CAPACITY: 55,000 lbs. at 100 ft.-lbs. input torque
- ULTIMATE LOAD CAPACITY: 170,000 lbs.
- SIDE-LOAD CAPACITY: 30,000 lbs.

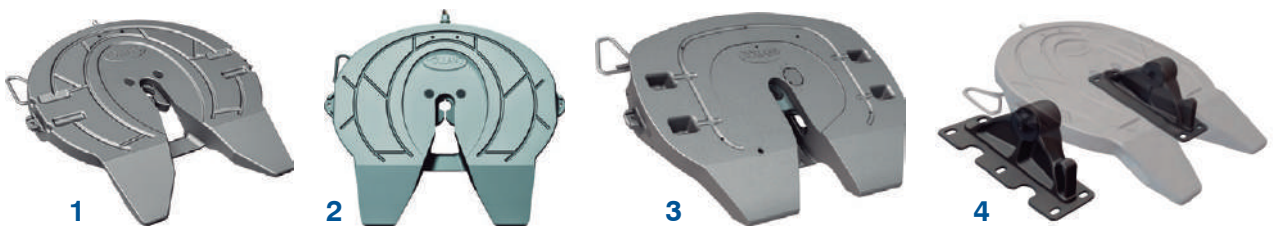

#	PART#	Description	Notes
1	XA-351-A-L-P	Holland Top Plate FW35 Series	<ul style="list-style-type: none"> <li>• Maximum Vertical Load: 55,000 lbs</li> <li>• Maximum Drawbar Pull: 150,000 lbs</li> </ul>
2	FW35Y800XL00	Holland Fifth Wheel Assembly FW35 Series with Brackets	<ul style="list-style-type: none"> <li>• Maximum Vertical Load: 55,000 lbs</li> <li>• Maximum Drawbar Pull: 150,000 lbs</li> </ul>
3	XA-S1-A-L-P	Holland Top Plate FWS1 Series	<ul style="list-style-type: none"> <li>• LOAD CAPACITY: 50,000 lbs. Vertical Load</li> <li>• PULL CAPACITY: 150,000 lbs. Drawbar Pull</li> </ul>
4	RK-Y800	Holland Fifth Wheel Mounting Brackets	<ul style="list-style-type: none"> <li>• Includes 1 pair (2 Brackets) Fits FW35 and FWS1 Series</li> </ul>





Heavy Duty Truck & Trailer Parts

# 5th WHEELS AND PARTS

## 5TH WHEEL REPAIR KIT

<b>FortproUSA#:</b> F286415
<b>Replaces:</b> RK351A02L
<b>Notes:</b> XA351 Series, XA331 Series, XA3500 Series



## 5TH WHEEL LOCK KIT

<b>FortproUSA#:</b> F286417
<b>Replaces:</b> XA07296
<b>Notes:</b> XA351 Series, XA331 Series, XA3500 Series



## 5TH WHEELS BUSHING

<b>FortproUSA#:</b> F286420
<b>Replaces:</b> XB00112, 11-0552, E7450
<b>Notes:</b> 3500 Series



## KING PIN

<b>FortproUSA#:</b> F286401
<b>Replaces:</b> E700
<b>Notes:</b> 2"



## PIN LOCK

<b>FortproUSA#:</b> F286405
<b>Replaces:</b> E702
<b>Notes:</b> Includes 2 Keys



## STEERING COMPONENTS

### KING PIN KITS



FortProUSA#	Replaces	Application	Notes
F265830	301SQ46B	Mack	R & RD
F265831	301SQ47E	Mack	R & RD
F265832	301SQ47CP1	Mack	R & RD
F265833	R200195, KB823	Mack	R & RD
F265834	R200198, KB547	Mack, Freightliner, Inter, Kenworth	
F265837	R200071, 301SQ52A	Mack	DM
F265838	301SQ53	Mack	Granite
F265842	K591B, KB846	Kenworth, Peterbilt, Mack, GMC, Ford	
F265843	R200281, KB850	Freightliner, Kenworth, Peterbilt, Inter, White	
F265844	R201419, KB826	Eaton, Freightliner, Kenworth, International	
F265846	KB325, 399942C93	International	
F265847	KB852	Kodiak	
F265848	KB477AR	Ford, International	





Heavy Duty Truck & Trailer Parts

# STEERING COMPONENTS

## TIE RODS



FortProUSA#	Replaces	Application	Notes
F265858	ES423L, R230068	Mack, Inter	L
F265859	ES423R, R230069	Mack, Inter	R
F265860	ES187R, 10QH248	Mack	R
F265861	ES187L, 10QH248P2	Mack	L
F265862	ES431R, 10QH248P3	Mack	R
F265863	ES431L, 10QH248P4	Mack	L
F265864	ES2091R, 10QH248P5	Mack	R
F265865	ES2091L, 10QH248P6	Mack	L
F265866	ES3225R, 18QK214	Mack	R
F265882	ES411R, 269-2234, 1649638C91	International	R
F265883	ES411L, 269-2235, 1649637C91	International	L
F265886	ES3476, 60961028, E10137	Freightliner, Inter, Peterbilt	R
F265887	ES3477, 60961027, E10138	Freightliner, Inter, Peterbilt	L
F265892	1258107, ES3274L	Kodiak	L
F265893	1258108, ES3275R	Kodiak	R



## STEERING COMPONENTS

### POWER STEERING PUMPS



FortproUSA#: **F255701**

Replaces: V10F1P7P38D5G20, 38QC375P1

Application: Mack

Rotation: Right

### POWER STEERING PUMPS



FortproUSA#: **F255702**

Replaces: V20F1P8P38D5H22, 38QC367P26

Application: Mack

Rotation: Right

### POWER STEERING PUMPS



FortproUSA#: **F255703**

Replaces: 1315R/18, 3406Z07-010-A

Application: Cummins 6CT

Rotation: Right

### POWER STEERING PUMPS



FortproUSA#: **F255704**

Replaces: 1316R/97, 34004A-010-B

Application: Cummins 6BT

Rotation: Right

### POWER STEERING PUMPS



FortproUSA#: **F255705**

Replaces: 1418R/45, 3406N-001

Application: Cummins 6BT AA

Rotation: Right



## STEERING COMPONENTS

### POWER STEERING PUMPS ■

<b>FortproUSA#:</b> F255707
<b>Replaces:</b> 0810L/276-1
<b>Application:</b> CAT 3116
<b>Rotation:</b> Left



### POWER STEERING PUMPS ■

<b>FortproUSA#:</b> F255708
<b>Replaces:</b> 2107550, 542-0176-10
<b>Application:</b> Detroit S60 / CAT 3406
<b>Rotation:</b> Left



### POWER STEERING PUMPS ■

<b>FortproUSA#:</b> F255709
<b>Replaces:</b> 2106721, 542-0169-10
<b>Application:</b> Freightliner, Inter, Kenworth
<b>Rotation:</b> Left



### POWER STEERING PUMPS ■

<b>FortproUSA#:</b> F255710
<b>Replaces:</b> 2107922, 542-0191-10
<b>Application:</b> Inter, Cummins
<b>Rotation:</b> Left



### POWER STEERING PUMPS ■

<b>FortproUSA#:</b> F255711
<b>Replaces:</b> 2108653, 542-0267-10
<b>Application:</b> Inter, Cummins, N14
<b>Rotation:</b> Right





## STEERING COMPONENTS

### POWER STEERING PUMPS



<b>FortproUSA#:</b> F255712
<b>Replaces:</b> 2106723, 542-0065-10
<b>Application:</b> Freightliner, Cummins N14
<b>Rotation:</b> Right

### POWER STEERING PUMPS



<b>FortproUSA#:</b> F255713
<b>Replaces:</b> 2107544, 542-0320-10
<b>Application:</b> Cummins, 6CT, CAT 3116
<b>Rotation:</b> Right

### POWER STEERING PUMPS



<b>FortproUSA#:</b> F255714
<b>Replaces:</b> 542-0130-10, 1663204C91
<b>Application:</b> International
<b>Rotation:</b> Right

### POWER STEERING PUMPS



<b>FortproUSA#:</b> F255715
<b>OEM No.:</b> 7840124
<b>Apply to:</b> SAGINAW 7840099/7840097

### POWER STEERING PUMPS



<b>FortproUSA#:</b> F255716
<b>OEM No.:</b> EV221618L 10101S



## STEERING COMPONENTS

### POWER STEERING PUMPS ■

FortproUSA#: <b>F255717</b>
OEM No.: LUK 542 0273 10
Apply to: INTERNATIONAL 1686649 C91



### POWER STEERING PUMPS ■

FortproUSA#: <b>F255718</b>
OEM No.: PS251615L102



### POWER STEERING PUMPS ■

FortproUSA#: <b>F255719</b>
OEM No.: V20F1P9P38C6G20
Apply to: VICKERS



### POWER STEERING PUMPS ■

FortproUSA#: <b>F255720</b>
OEM No.: EV221615L 101



### POWER STEERING PUMPS ■

FortproUSA#: <b>F255721</b>
OEM No.: PEV1816-15R101





6300 NW 84 AVE  
MIAMI, FL 33166 - USA

Heavy Duty Truck & Trailer Parts

## STEERING COMPONENTS

### POWER STEERING PUMPS



FortproUSA#: **F255723**

OEM No.: PS221615L116

Apply to: TRW PS

### POWER STEERING PUMPS



FortproUSA#: **F255724**

OEM No.: 2008180C93

### POWER STEERING PUMPS



FortproUSA#: **F255722**

OEM No.: 2010-412-C92





Heavy Duty Truck & Trailer Parts

# AIR SPRING



FortProUSA#	Replaces	Application	Notes
F245584	9780, 1R12-303	Freightliner	Plastic
F245585	9781, 1R12-603	Freightliner	Alum
F245581	9375,1R12-404, 57QL414M, 50899-002L	Mack	Vision
F245582	9466, 1R12-365, 57QL411M, 49048-002L	Mack	Early CH Models
F245583	9082, 1R12-092, 517559C9		
F245586	9270, 1R13-119		
F245587	9069, 1R12-069	Peterbilt	
F245588	9422, 1R11-028	Kenworth	
F245571	7007, 1S4-067, 227QS34B	Mack	R Models
F245572	7087, 1S5-040 (Air Cab)	Freightliner	FLD 120
F245573	7206, 18-29919-000 (Air Cab)	Freightliner	Columbia
F245574	7001, 1S4-007, 227QS33, 7002, 7031	Mack	
F245575	7017, 1S5-055, 227QS38	Mack	
F245576	1S6-025, 227QS312AM	Mack	CH Model
F245579	800-6222086001	Mack / Universal	Seat
F245555	6891, 2B9-252, 6944		
F245556	7410, 2B12-406		
F245557	6932, 2B9-246		
F245558	6945 , 2B9-253		
F245559	8032, 3B12-315		
F245560	7800, 3B14-360		
F245561	6902, 2B9-201		
F245562	6905, 2B9-206		





## Heavy Duty Truck & Trailer Parts

# AIR SPRING



FortProUSA#	Replaces	Application	Notes
F245590	8204, 1R12-508	Neway	Tandem
F245591	8713, 1R13-176	Hendrickson	Tandem
F245592	8755, 1R13-124	Hendrickson	Tandem
F245593	8729, 1R13-130, 202796	Meritor	Tandem
F245594	1R14-152, S-25319	Hendrickson	Granite
F245580	9875, 1R12-432	International	
F245595	9648, 1R12-538	International	
F245596	8852, 1R12-568	Peterbilt	
F245597	8829, 1R12-615	Volvo	
F245598	8708, 1R13-177	Hendrickson	
F245599	9039, 1R12-095	Trailer	
F245569	9622, 1R11-221	Kenworth	
F245570	1R12-487, 9366	Trailer	
F245577	1S4-173, 227QS42M	Mack	Air Cab
F245644	6897, 2B9-229	Trailer	
F245645	554787C1, 2B12-307, 7403	Hendrickson	
F245646	7137, 554798C1, 2B14-356	Hendrickson	
F245647	7135, 554800C1, 2B14-360	Hendrickson	
F245648	7036, 1S5-186	Peterbilt	Air Cab
F245649	7064, 7075, 1S5-157	Kenworth	Air Cab
F245578	7110, 1S5-152, R81-1001	Kenworth	Air Cab
F245600	1S5-175, 18040977-000, 17205, 7207, 7215	Freightliner	Air Cab







Heavy Duty Truck & Trailer Parts

**SHOCK ABSORBERS**

FortProUSA#	Replaces	Application
F247901	83001	Cab Century
F247902	83002	Cab Kenworth
F247903	83003, 14QK374, 14QK376	Cab Mack
F247904	83008	Cab Peterbilt
F247905	83009	Cab FL, Classic, Columbia
F247906	83019, 14QK2111, 5065	Cab Mack R Models
F247907	83025	Cab KW, GMC, FL, PETE, INT, FORD
F247908	83029	Cab Volvo
F247909	83038	Cab Century, Columbia
F247910	83041, 14QK391AM, 5055	Cab Mack CH / CL / CV / CX Models
F247911	83123, 14QK393AM, 14QK375M, 5057	Rear HDK, MACK CH, KW, INTER, PETE, VOLVO
F247912	83125, 14QK410M, 5071	Rear HDK, MACK, INTER, FORD, VOLVO, STER
F247913	83209, 14QK372M2	Rear HDK, MACK, INTER, PETE, KW, VOLVO, GMC
F247914	83215, 14QK2107P1, 5095	Rear MACK
F247915	85000	Rear HDK, FL, KW, PETE, VOLVO
F247916	85001, 14QK2113	Front / Rear MACK, PETE, FORD, VOLVO
F247917	85003	Rear KW, VOLVO, INTER, PETE
F247918	85005, 14QK392BM, 65110, 5056	Front / Rear HDK, MACK, VOLVO, STER, KW, INTER, FL, FORD, GMC, BLUE
F247919	85006	Front / Rear HDK, VOLVO, STER, FL, FORD, BLUE
F247920	85025	VOLVO
F247921	85029	Front / Rear HDK, FL, INTER, BLUE
F247922	85036, 14QK366P1, 5075	Front MACK R Models
F247923	85052	TRAILER HDK, REYCO, SAF
F247924	85061, 14QK431M, 14QK3114M, 20973993, 5084	Front MACK VISION / Rear VOLVO
F247925	83147, 14QK424M, 20570098, 60670-006, 750777	Rear HDK, MACK VISION / GRANITE
F247926	85062	Front KW, PETE, VOLVO
F247927	85066, 14QK2136M, 20433425	Rear MACK, VOLVO
F247928	85067	Rear KW, PETE
F247929	85069	Front KW, PETE
F247930	85310, 650404	Rear KW, PETE, MACK, VOLVO
F247931	85311	Front / Rear KW, MACK, VOLVO, INTER, PETE
F247932	85319	Rear FL, KW, MACK, PETE, VOLVO
F247933	85320	Front FL, KW, PETE, VOLVO
F247934	85724	Rear Freightliner
F247935	85918	Front Freightliner
F247936	85931	Rear INTER
F247937	89408	GAS / KW, VOLVO, PETE
F247938	89410, 14QK2113, 14QK2133M2, 25632145	GAS / KW, VOLVO, PETE, MACK
F247939	89429	GAS / FL, VOLVO, KW, PETE





## TRAILER SPRINGS

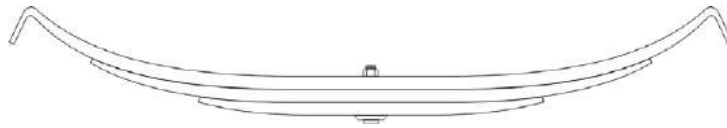

FortProUSA#	Replaces	# Leaves	Arch	Wide	Length A	Length B	Pack Thick	Notes
F247950	TRA-2726	3	6"	3"	22 1/2"	23 5/8"	2 1/2"	354-00
F247951	TRA-2727	3	4 1/2"	3"	21 3/4"	22 7/8"	2 1/2"	355-00
F247952	TRA-2727HD	4	3 3/4"	3"	21 3/4"	22 7/8"	3 5/16"	
F247953	TRA-2728	3	3 5/8"	3"	21 1/4"	22 7/16"	2 1/2"	356-00
F247954	TRA-2740	3	5 1/2"	3"	22"	23 3/4"	2 15/16"	365-00
F247955	TRA-2741	3	3 1/4"	3"	21 1/2"	22 3/4"	2 15/16"	365-01
F247956	TRA-2752	2	6 1/2"	3"	22 1/2"	24"	1 15/16"	324-01
F247957	TRA-2754	2	4 1/4"	3"	21 5/8"	23 1/4"	1 15/16"	326-01
F247958	TRA-2260	8	4 15/16"	3"	21 3/8"	23 1/8"	4"	752-05
F247959	TRA-2270	8	3 5/8"	3"	21 11/16"	21 11/16"	4"	T3564
F247960	TRA-2297	9	2 1/2"	3"	21 3/8"	21 3/8"	4 1/2"	T7452
F247961	TRA-2297HD	10	2 1/2"	3"	21 3/8"	21 3/8"	5"	
F247962	TRA-3340	3	5 7/8"	3"	22 1/2"	24 1/8"	2 1/2"	0079-01
F247963	TRA-3341	3	3"	3"	21"	23 3/4"	2 1/2"	54-122
F247964	TRA-021	1	4 11/16"	3"	21 7/8"	23 1/4"	1 3/8"	363-00
F247965	TRA-023	1	7 1/16"	3"	22 1/2"	24 3/16"	7 1/16"	360-00
F247966	TRA-038	1	4 1/2"	3"	21 1/2"	22 1/4"	1 5/8"	54-112
F247967	TRA-2732	8	2 3/4"	3"	20 3/4"	22 3/8"	4"	752-01





Heavy Duty Truck & Trailer Parts

# TRUCK SPRINGS

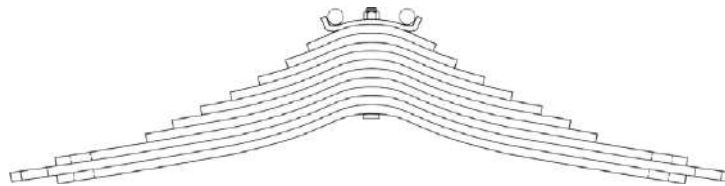

FortProUSA#	Replaces	# Leaves	Arch	Wide	Length A	Length B	Notes
F247971	62-143, 4QK4004A, 25192117	11	6 7/8"	4"	30 5/8"	28 1/4"	MACK
F247972	62-147, 4QK4005A	10	6 13/16"	4"	28 5/16"	25 15/16"	MACK
F247973	62-890, 78-665	13	5"	3 1/2"	25 1/8"	30 1/2"	MACK
F247974	62-868, 2QK3323, 25060652	14	5 1/2"	3 1/2"	25 1/8"	30 1/4"	MACK

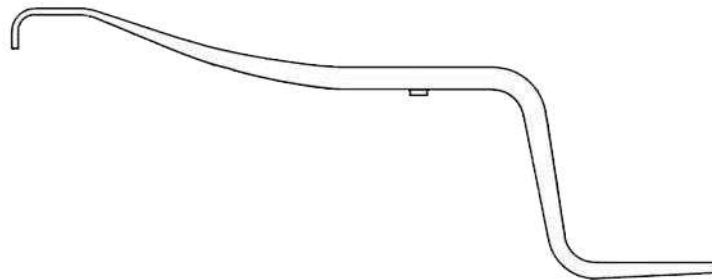

FortProUSA#	Replaces	# Leaves	Arch	Wide	Length A	Length B	Notes
F247981	50-389, 56946-000, 4QK4150M	1	11 1/2"	3"	24"	19 5/8"	MACK





Heavy Duty Truck & Trailer Parts

**HENDRICKSON**

**LOAD CUSHION**



FortproUSA#: **F184283**

Replaces: 49377000, 60879000

Notes: Hendrickson HN 402/462/522 & 400/460  
11/88 -2/96 Hendrickson HN Series = 2Pcs

**REBOUND PAD**

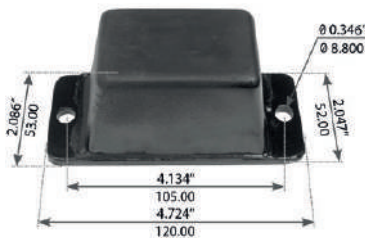

FortproUSA#: **F184279**

Replaces: 49395000, MN1881

Notes: Hendrickson HN400/460 11/88 To 2/96  
Suspensions Hendrickson Norde  
HN460 Suspensions

**TRI FUNCTIONAL BUSHING KIT**



FortproUSA#: **F184264**

Replaces: 2963, S24112, S24681

Notes: Hendrickson Turner Trailer: Intraxx®;  
AAL23K, 25K, 30K, AANL23K, AAEDL30K,  
Lowride, AA230L, 250L, 300L Suspension

**TORQUE ARM BUSH**

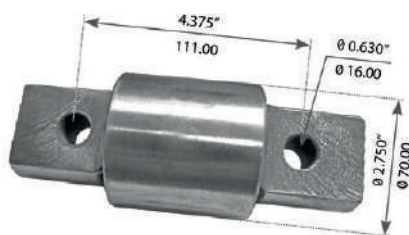

FortproUSA#: **F184213**

Replaces: 666490002L, 666492

Notes: Hendrickson Rear AG100 Air Glide

**TORQUE ARM BUSH**

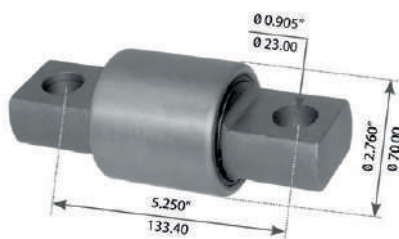

FortproUSA#: **F184214**

Replaces: 666490003L, 666493

Notes: Hendrickson Torque Arm Bush



# HENDRICKSON

## TORQUE ARM BUSH

FortproUSA#: <b>F184234</b>
Replaces: 64809000
Notes: Hendrickson Primaax / Firemaax

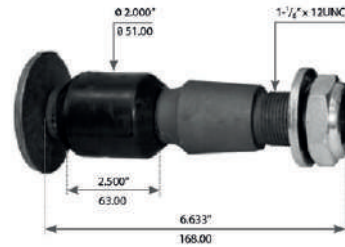

## TORQUE ARM BUSH

FortproUSA#: <b>F184208</b>
Replaces: 47691, 47691000
Notes: Hendrickson; Rear E4 Series, All

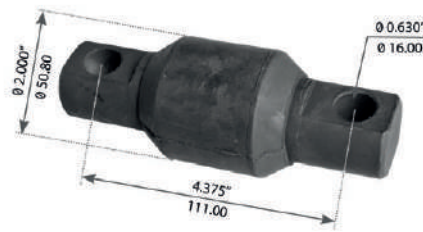

## BEAM END BUSH

FortproUSA#: <b>F184205</b>
Replaces: 45900000
Notes: Hendrickson AR2 400/460/520, HN, RS, RT/RTE2 340/380/520, RU/RUE, U/UE 340/380, SR 340, VR 340/380 Suspension



## KIT, BEAN ADAPTER

FortproUSA#: <b>F184207</b>
Replaces: 45000-7L
Notes: 4000 - 450007



## TORQUE ARM BUSH

FortproUSA#: <b>F174003</b>
Replaces: 666490003L, 666493
Notes: Hendrickson Torque Arm Bush

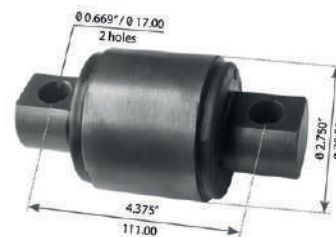



## Heavy Duty Truck & Trailer Parts

# HENDRICKSON

### TORQUE ARM BUSH

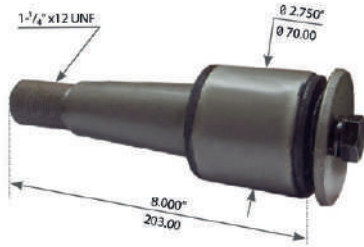

FortproUSA#: **F184209**

Replaces: 229610, 44697

Notes: Hendrickson 380-520 Series

### BEAM END BUSHING KIT



FortproUSA#: **F184267**

Replaces: 2202, 102202, A6914, S6914

Notes: Hendrickson HT Air Suspension  
(All Except T9-278)

### LOAD CUSHION



FortproUSA#: **F184284**

Replaces: 52957000, 64179002

Notes: Hendrickson Haulmaax

### TORQUE ARM BUSH



FortproUSA#: **F184217**

Replaces: 64400002, 64400002L

### EQUALIZER BUSH

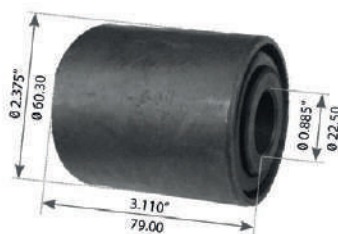

FortproUSA#: **F184242**

Replaces: 47421

Notes: Hendrickson E4 Series All



# HENDRICKSON

## TORQUE ROD BUSH

FortproUSA#: <b>F184216</b>
Replaces: 69210000
Notes: Hendrickson Primaax / Firemaax



## TORQUE ROD BUSH

FortproUSA#: <b>F184235</b>
Replaces: 64697000
Notes: Hendrickson Rear Haulmaax

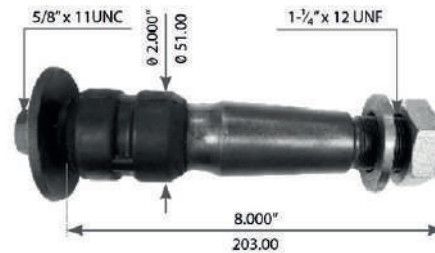

## BOLSTER SPRING KIT

FortproUSA#: <b>F184285</b>
Replaces: 64179037
Notes: Hendrickson Rear Haulmaax



## TORQUE ARM BUSH

FortproUSA#: <b>F184230</b>
Replaces: 49210000

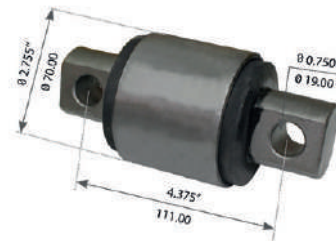

## CENTER BUSHING

FortproUSA#: <b>F184204</b>
Replaces: 5919000
Notes: Hendrickson AR 340/380, R 400/460/480/520, RT/RTE, RT2/RTE2 380/520, SR 340, V4 340/380 Series

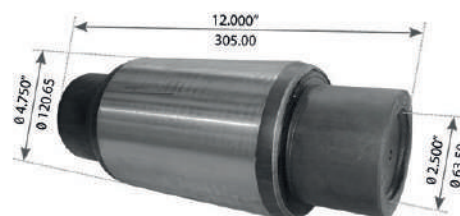



Heavy Duty Truck & Trailer Parts

**HENDRICKSON**

**BAR PIN BUSHING KIT WITH SHIM**



FortproUSA#: **F184203**

Replaces: 1117653B001, 34013088

Notes: Hendrickson AR 340/380, AR2 400/460/520, Haulmaax, HN, R 400/460/480/520, RS, RT/RTE, RT2/RTE2 340/380/520, RU/RUE, U/UE 340/380 Series

**CENTER BUSHING**

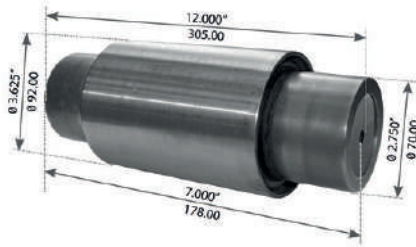

FortproUSA#: **F184206**

Replaces: 6664000

Notes: Hendrickson Rear: AR 340/380 Series, Rear: RT/RTE, RT2/RTE2 340 Series Suspension

**CENTER BUSHING**

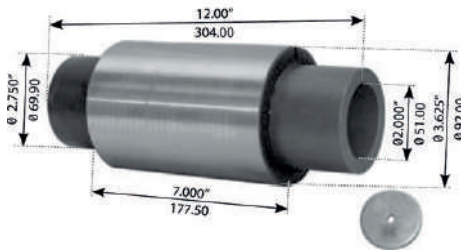

FortproUSA#: **F184224**

Replaces: 22279000

Notes: Hendrickson Rear: SR 340 Series, Rear: V4 340/380 Series Suspension

**BEAM END BUSH**

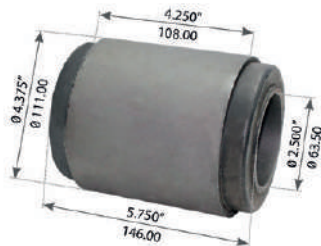

FortproUSA#: **F184244**

Replaces: 29878001

Notes: Hendrickson Rear: RT/RTE, RT2/RTE2 380/520 Series, Rear: AR2 400/460/520 Series Suspension

**CENTER BUSHING**

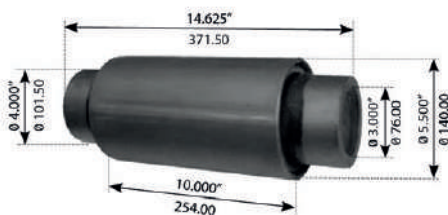

FortproUSA#: **F184254**

Replaces: 10366000

Notes: Hendrickson Rear: RT 650 Series Suspension







# Heavy Duty Truck & Trailer Parts

## HENDRICKSON

### TORQUE ARM BUSH

FortproUSA#: <b>F184231</b>
Replaces: 44809000
Notes: Hendrickson 340 520 Series Suspension

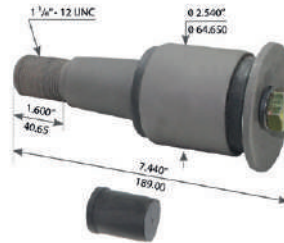

### TORQUE ARM BUSH

FortproUSA#: <b>F184225</b>
Replaces: 46737000
Notes: Hendrickson 340 520 Series Suspension

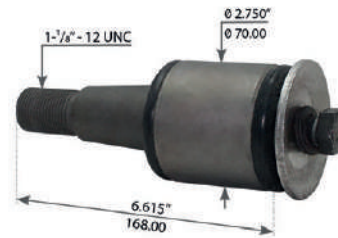

### TORQUE ARM BUSH

FortproUSA#: <b>F184226</b>
Replaces: 46734000
Notes: Hendrickson Maxi Rod Offset Suspension

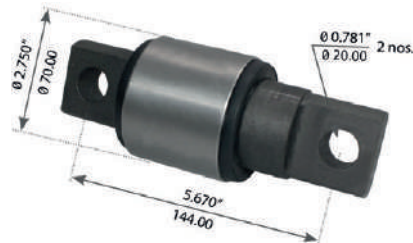

### TORQUE ARM BUSH

FortproUSA#: <b>F184210</b>
Replaces: 47699-001L

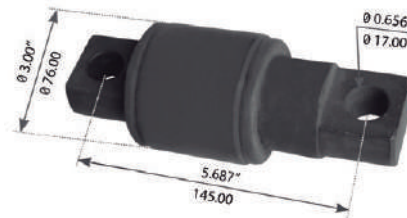

### TORQUE ARM BUSH

FortproUSA#: <b>F184248</b>
Replaces: 46736000



# HENDRICKSON

## SLIPPER PAD

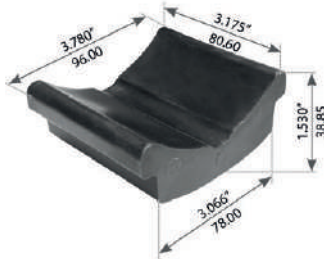

FortproUSA#: **F184287**

Replaces: 56929000

Notes: Hendrickson Rear: HAS 360/400/402/460/40LH Suspension

## SLIPPER PAD KIT



FortproUSA#: **F184289**

Replaces: 56557004

Notes: Hendrickson Rear: HAS 360/400/402/460/40LH Suspension

## TORQUE ARM BUSH



FortproUSA#: **F184211**

Replaces: 45477000

Notes: Hendrickson Rear Haulmaax

## LOAD CUSHION

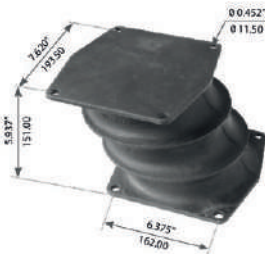

FortproUSA#: **F184286**

Replaces: NM1010

## TORQUE ROD BUSH



FortproUSA#: **F174001**

Replaces: 46735000

Notes: Mack SS34-38, SS44, SWS573

# HENDRICKSON

## TORQUE ARM BUSH

FortproUSA#: **F174002**

Replaces: 227710, 44694

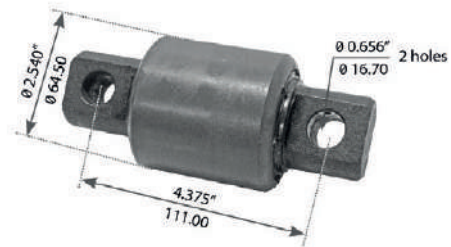

## TORQUE ARM BUSH

FortproUSA#: **F184229**

Replaces: 57256000

Notes: Hendrickson Rear: HA Series

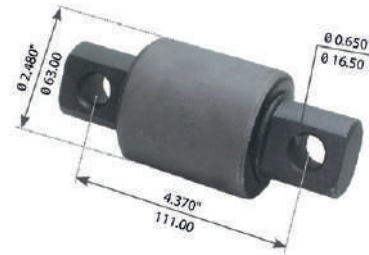

## BEAM BUSHING KIT

FortproUSA#: **F184201**

Replaces: E2863



## KIT, BUSHING

FortproUSA#: **F184202**

Replaces: 30437, 30437-000L



## END, TORQUE ROD

FortproUSA#: **F184220**

Replaces: 46610

Notes: 4000-46610000





6300 NW 84 AVE  
MIAMI, FL 33166 - USA

## Heavy Duty Truck & Trailer Parts

# HENDRICKSON

### END, TORQUE ROD



FortproUSA#: **F184221**

Replaces: 46661

Notes: 4000-46661000

### END, TORQUE ROD



FortproUSA#: **F184222**

Replaces: 46681

Notes: 40000-46681000

# FREIGHTLINER

### CABIN MOUNT

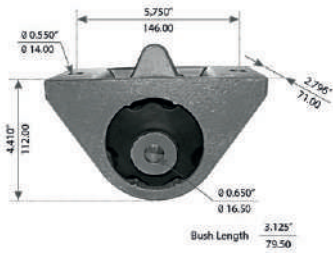

FortproUSA#: **F317233**

Replaces: 1845384000, A1844009000, M17419

Notes: Freightliner Century & Columbia Series Trucks

### CABIN MOUNT

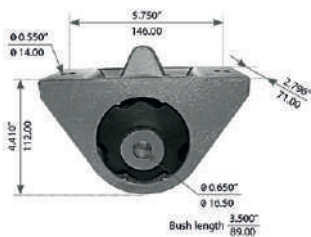

FortproUSA#: **F317234**

Replaces: 1841005000, A1834677000, M17420

Notes: Freightliner Century & Columbia Trucks

116



Any reference to OEM names or OEM product identification numbers/descriptions/pictures/model numbers is for identification only and does not indicate that it is an OEM part. When ordering, customers have the option to order using industry references, OEM references or FortProUSA references.

# FREIGHTLINER

## FREIGHTLINER

**FortproUSA#:** F317235  
**Replaces:** 1835445000, A18345959000, M17421  
**Notes:** Freightliner Arogosy Front Cabin



## FREIGHTLINER

**FortproUSA#:** F317236  
**Replaces:** LORJ2094136, LORJ2094416, M17347  
**Notes:** Freightliner FLD 120 Series Trucks



## CABIN MOUNT

**FortproUSA#:** F317237  
**Replaces:** 6818900001, LORDB3331007B, M17337  
**Notes:** Freightliner FLD 120 Series Trucks



## CABIN MOUNT

**FortproUSA#:** F317238  
**Replaces:** LORSSB3310018, SSB3310018, M17334  
**Notes:** Freightliner FLD 120, FLT Series Trucks



## CABIN MOUNT

**FortproUSA#:** F317239  
**Replaces:** 1847463000, M17427  
**Notes:** Freightliner Business Class M2 Trucks



# FREIGHTLINER

## ■ CABIN MOUNT, FRONT



FortproUSA#: **F317240**

Replaces: 1859922000, M17431

Notes: Freightliner Trucks

## ■ ENGINE MOUNT, UPPER



FortproUSA#: **F317241**

Replaces: BCD273301, BCD273302, M17395

Notes: Freightliner Columbia & Century Trucks

## ■ MOTOR MOUNT



FortproUSA#: **F317242**

Replaces: BCD288051, M17404

Notes: Freightliner Century Series Suspensions

## ■ MOTOR MOUNT



FortproUSA#: **F317243**

Replaces: BCD274772, M17397

Notes: Freightliner Columbia & Century Series Suspensions

## ■ MOTOR MOUNT KIT



FortproUSA#: **F317244**

# FREIGHTLINER

## MOTOR MOUNT

<b>FortproUSA#: F317245</b>
<b>Replaces:</b> CBA2465017, M17330
<b>Notes:</b> Freightliner FLD 120 Series Trucks



## MOTOR MOUNT

<b>FortproUSA#: F317246</b>
<b>Replaces:</b> 6816910001, LORSSB3310017, SSB3310017A / M17335
<b>Notes:</b> Freightliner FLD Series Suspensions



## MOTOR MOUNT, FRONT

<b>FortproUSA#: F317247</b>
<b>Replaces:</b> BCD267033, BCD276512, BCD276513, M17413
<b>Notes:</b> Freightliner Columbia & Century Series Suspensions

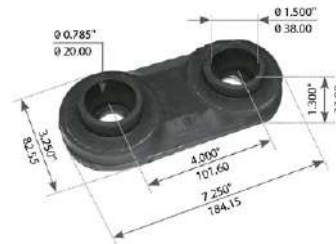

## MOTOR MOUNT, LOWER

<b>FortproUSA#: F317248</b>
<b>Replaces:</b> BCD267041, BCD289451, M17403
<b>Notes:</b> Freightliner Columbia & Century Series Trucks



## MOTOR MOUNT KIT

<b>FortproUSA#: F317249</b>
<b>Replaces:</b> M17403K
<b>Notes:</b> Freightliner Columbia & Century Series





# FREIGHTLINER

## HOOD CONE



FortproUSA#: **F317250**

Replaces: A1710464001, M17331

Notes: Freightliner FLD Series Suspensions

## RADIATOR MOUNT



FortproUSA#: **F317251**

Replaces: BCD287211, BCD288471, M203055

Notes: Freightliner FL70, FL80 Series Suspensions

## RADIATOR MOUNT

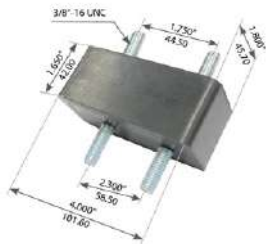

FortproUSA#: **F317252**

Replaces: 6805040182, 6805040382, M17418

Notes: Freightliner FC70, FC80, FLB, M2 106 Series Suspensions

## SPRING EYE BUSH



FortproUSA#: **F317260**

Replaces: 59259002

Notes: Freightliner Front Airtel Airliner, Sterling Airliner & Western Star-Suspension

## TORQUE ARM BUSH



FortproUSA#: **F184208**

Replaces: A16119448000

Notes: Freightliner Rear Fas Airliner II & Sterling Suspension







# Heavy Duty Truck & Trailer Parts

## FREIGHTLINER

### TORQUE ARM BUSH

<b>FortproUSA#:</b> F174003
<b>Replaces:</b> 169306101, 227720, 44695000
<b>Notes:</b> Freightliner Rear 4" Spring Suspension



### TORQUE ARM BUSH

<b>FortproUSA#:</b> F184209
<b>Replaces:</b> 44697



### TORQUE ARM BUSH

<b>FortproUSA#:</b> F317261
<b>Replaces:</b> 81897
<b>Notes:</b> Freightliner Rear Fas Airliner II Suspension



### SPRING EYE BUSH

<b>FortproUSA#:</b> F317262
<b>Replaces:</b> 1616412001, 1618035000, 6813250250, W300861, RB268
<b>Notes:</b> Freightliner Fas 11 Air Ride Suspension Freightliner Fas II Airliner

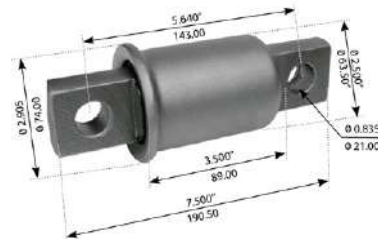

### SPRING EYE BUSH

<b>FortproUSA#:</b> F317224
<b>Replaces:</b> 6813250150, RB205
<b>Notes:</b> Freightliner Rear Fas Airliner II Suspension



121





# FREIGHTLINER

## SPRING EYE BUSH

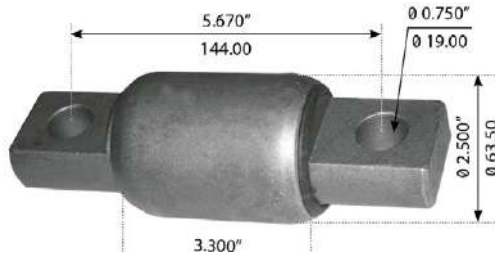

FortproUSA#: **F317264**

Replaces: 1613962000, RB234

Notes: Freightliner Rear Fas Airliner II Suspension

## WEAR PAD

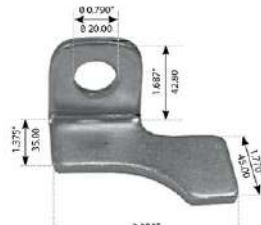

FortproUSA#: **F317265**

Replaces: 1616456000, 6813252109

Notes: Freightliner Rear Fas Airliner II  
(Freightliner & Sterling) Suspension

## WEAR PAD



FortproUSA#: **F317266**

Replaces: 1616456001, 6813252209

Notes: Freightliner Rear Fas Airliner II  
(Freightliner & Sterling) Suspension

## BOLSTER SPRING



FortproUSA#: **F317267**

Replaces: 16145080000, 1614508001,  
1615010000

Notes: Freightliner Tuftrac 40K, 46K, 52K  
Suspension

## LOWER PAD, SPRING

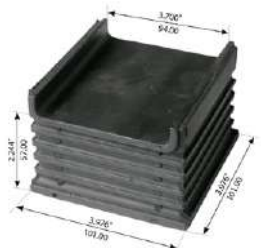

FortproUSA#: **F317268**

Replaces: 1120807000

Notes: Freightliner Tuftrac 40K, 46K, 52K  
Suspension



# FREIGHTLINER

## UPPER PAD, SPRING INSULATOR

<b>FortproUSA#:</b> F317269
<b>Replaces:</b> 1120808000
<b>Notes:</b> Freightliner Tuftrac 40K, 46K, 52K Series Suspension



## TORQUE ROD BUS KIT

<b>FortproUSA#:</b> F317270
<b>Replaces:</b> 62480016000
<b>Notes:</b> Freightliner Tuftrac 40K, 46K, 52K Series Suspension



## SPRING EYE BUSH

<b>FortproUSA#:</b> F317272
<b>Replaces:</b> 1617769000, 6803220150, 6803220301, RB211
<b>Notes:</b> Freightliner M2 & Sterling Acterra 3.0" & 4.0" WD Eye & Slipper Suspension Freightliner F Series (W/56" SPG.), M Series, Century, Columbia, Coronado, Cascadia Rogosy Condor Sterling Acterra, A, L, S Series FOR CON & COE Suspension



## BOLSTER SPRING SEAT

<b>FortproUSA#:</b> F317273
<b>Replaces:</b> 119581000
<b>Notes:</b> Freightliner Rear Tuftrac 40K, 46K, 52K Series Suspension



## EQUALIZER BUSHING

<b>FortproUSA#:</b> F317218
<b>Replaces:</b> 1613568000, A1610549000, A1613570000, E1610512000
<b>Notes:</b> Freightliner Rear FH34, FH34A, FH36, FH38A, FH40, FH44A Suspension



# FREIGHTLINER

## SPRING EYE BUSH



FortproUSA#: **F317275**

Replaces: HR1HBU541, RB175

Notes: Freightliner Fas Airliner Suspension

## SPRING EYE BUSH

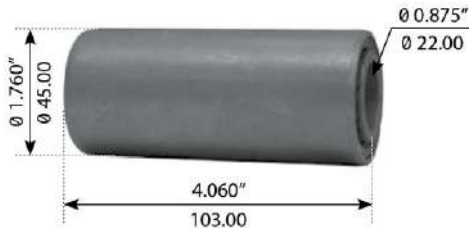

FortproUSA#: **F317277**

Replaces: 236840

Notes: Freightliner Rear Fas Airliner I Suspension

## SPRING EYE BUSH



FortproUSA#: **F317279**

Replaces: 1614603000, 1617770000, RB263

Notes: Freightliner Front 3.0" & 4.0" WD. Eye & Slipper, M2 & Sterling Acterra, MB FL Series Airtex Suspension

## SPRING EYE BUSH



FortproUSA#: **F317281**

Replaces: 1616133000, RB280

Notes: Freightliner 3.0" Eye/Eye Spring 46-1331, 1363, 1375 Suspension

## WEAR PAD



FortproUSA#: **F317286**

Replaces: 651001, RB249

Notes: Freightliner MB FL Series Suspension



# Heavy Duty Truck & Trailer Parts

## FREIGHTLINER

### TORQUE ARM BUSH

FortproUSA#: <b>F317288</b>
Replaces: 57256000
Notes: Freightliner Rear FH36, FH40 3" Spring (Freightliner & Sterling) Suspension

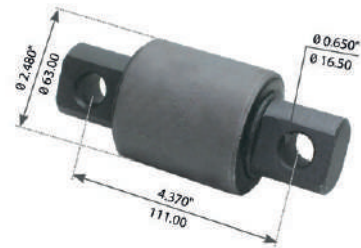

### EQUALIZER BUSHING ASSY

FortproUSA#: <b>F317217</b>
Replaces: A16-12591-000
Notes: E7706



### TORQUE ROD WITH BUSHING

FortproUSA#: <b>F317226</b>
Replaces: TMR513, E-3546, 345-185, 1610420001



### TORQUE ROD WITH BUSHING

FortproUSA#: <b>F317229</b>
Replaces: TMR514, 345-212, 6813266716



### TORQUE ROD WITH BUSHING

FortproUSA#: <b>F317230</b>
Replaces: TMR515, 345-213, 6813266316





6300 NW 84 AVE  
MIAMI, FL 33166 - USA

## Heavy Duty Truck & Trailer Parts

# FREIGHTLINER

### TORQUE ROD WITH BUSHING

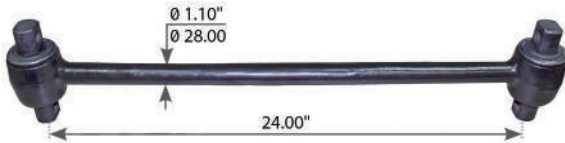

FortproUSA#: **F317225**

Replaces: TMR514F, 345-915, 1616749001

### TORQUE ROD WITH BUSHING



FortproUSA#: **F317227**

Replaces: TMR516, 345-208, 1613053000

### TORQUE ROD WITH BUSHING

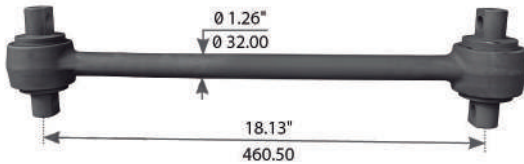

FortproUSA#: **F317210**

Replaces: TMR535, 345-868, 1616749002

### SPRING EYE BUSH



FortproUSA#: **F317231**

Replaces: 16-11890-001

Notes: E8795, W = 2", THK= 1", CTOC= 5-5/16"

### BEAM BUSHING KIT

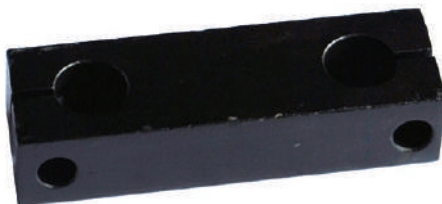

FortproUSA#: **F317232**

Replaces: 681-322-0020

Notes: L = 6-11/16", THK= 1", CTOC= 4-1/8"

126



Any reference to OEM names or OEM product identification numbers/descriptions/pictures/model numbers is for identification only and does not indicate that it is an OEM part. When ordering, customers have the option to order using industry references, OEM references or FortProUSA references.

# KENWORTH

## CABIN MOUNT

FortproUSA#: **F327366**

Replaces: K066269, K066336, M60270NR  
M17414

Notes: Kenworth T800 Series Trucks



## CABIN MOUNT

FortproUSA#: **F327367**

Replaces: 0514794, K066176, M17417

Notes: Kenworth T800 Series Trucks



## CABIN MOUNT

FortproUSA#: **F327368**

Replaces: 516401, K066229, M17406

Notes: Kenworth Trucks



## CABIN MOUNT BUSH

FortproUSA#: **F327369**

Replaces: K066218, M30070NR

Notes: Kenworth Airglide 200 Trucks



## CABIN MOUNT FRONT

FortproUSA#: **F327370**

Replaces: 2650911

Notes: Kenworth T800 Trucks Series

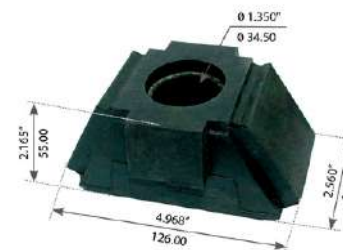

# KENWORTH

## CABIN REBOUND



FortproUSA#: **F327371**

Replaces: K0664353

Notes: Kenworth T600 T800 W900 Trucks Series

## CABIN ISOLATOR, FRONT



FortproUSA#: **F327372**

Replaces: 267322, M20308

Notes: Kenworth Trucks

## MOTOR MOUNT



FortproUSA#: **F327373**

Replaces: K066377, M17411

Notes: Kenworth T600 Series Trucks

## MOTOR MOUNT, FRONT



FortproUSA#: **F327374**

Replaces: K066385, K066406, M203039

Notes: Kenworth T600 & W900 Series Suspensions

## MOTOR MOUNT

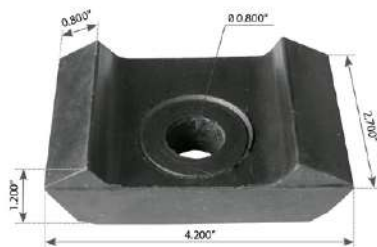

FortproUSA#: **F327375**

Replaces: K066421, M17409

Notes: Kenworth





# Heavy Duty Truck & Trailer Parts

## KENWORTH

### MOTOR MOUNT

FortproUSA#: <b>F327376</b>
Replaces: K066177, M50070NR, M17410
Notes: Kenworth Trucks



### MOTOR MOUNT

FortproUSA#: <b>F327377</b>
Replaces: K066282, M7405
Notes: Kenworth Trucks

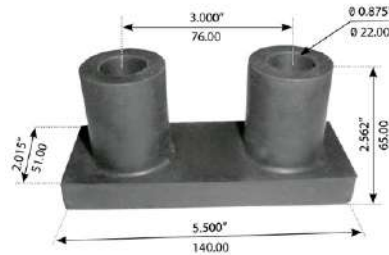

### MOTOR MOUNT

FortproUSA#: <b>F327378</b>
Replaces: K066247, M17404
Notes: Kenworth Trucks

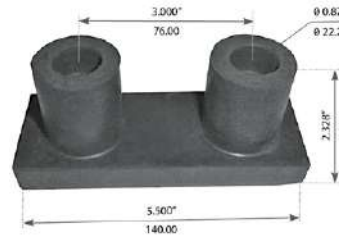

### MOTOR MOUNT

FortproUSA#: <b>F327379</b>
Replaces: K174555, K174B456, M7408
Notes: Kenworth Trucks



### MOTOR MOUNT

FortproUSA#: <b>F327380</b>
Replaces: EX110013, M17416
Notes: Kenworth Trucks 4" Spring SRI 75-232, 75-218

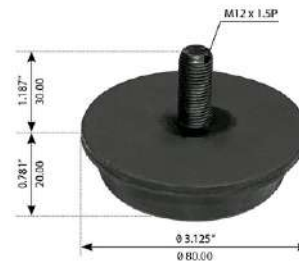

129





6300 NW 84 AVE  
MIAMI, FL 33166 - USA

## Heavy Duty Truck & Trailer Parts

# KENWORTH

### HOOD PIN

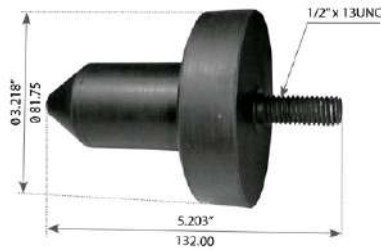

FortproUSA#: **F327381**

Replaces: 701000, K179528, K179D450, M17402

Notes: Kenworth H/CH Series Suspensions

### RADIATOR MOUNT



FortproUSA#: **F327382**

Replaces: K066228, M17412

Notes: Kenworth

### RADIATOR MOUNT KIT

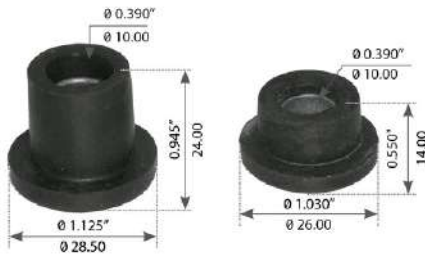

FortproUSA#: **F327383**

Replaces: M20070EP, M17429

Notes: Kenworth Trucks

### BUSHING, STEERING SHAFT



FortproUSA#: **F327384**

Replaces: R131014

Notes: Kenworth Trucks

### REBOUND WASHER



FortproUSA#: **F327385**

Replaces: K066381

Notes: Kenworth Rear Axle Stop Suspension

130



Any reference to OEM names or OEM product identification numbers/descriptions/pictures/model numbers is for identification only and does not indicate that it is an OEM part. When ordering, customers have the option to order using industry references, OEM references or FortProUSA references.

# KENWORTH

## TORQUE ARM BUSH

FortproUSA#: <b>F184203</b>
Replaces: 227720, 44695000
Notes: Kenworth Rear AG100 Airglide Suspension



## TORQUE ARM BUSH

FortproUSA#: <b>F184209</b>
Replaces: 44697000, 229610
Notes: Kenworth Rear AG 100 Airglide Suspension



## SPRING EYE BUSH

FortproUSA#: <b>F327351</b>
Replaces: B651006, RB295
Notes: Kenworth C500B/550B, K100/300, T300/400/450/600/800/2000 Trucks

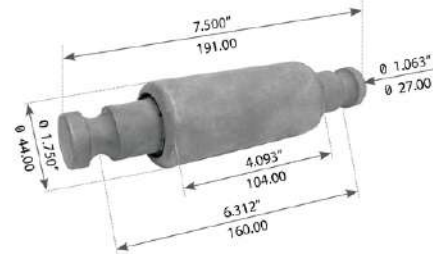

## SPRING EYE BUSH

FortproUSA#: <b>F327352</b>
Replaces: B651013, B656006, RB330
Notes: Kenworth Front C500B/550B, K100/300, T300/400/600/800/2000 Trucks

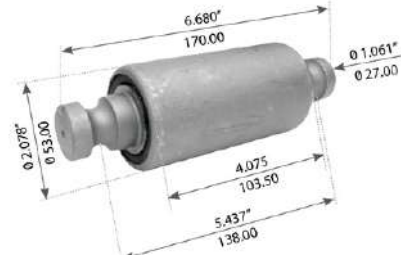

## SPRING EYE BUSH

FortproUSA#: <b>F327353</b>
Replaces: B651007, B651012, RB323
Notes: Kenworth Front C500B/550B, K100/300, T300/400/600/800/2000 Trucks

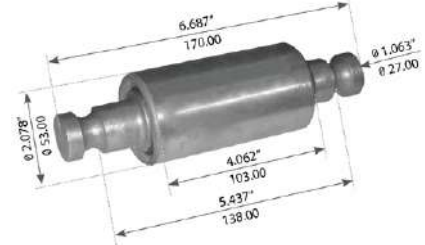

# KENWORTH

## TORQUE ROD BUSHING

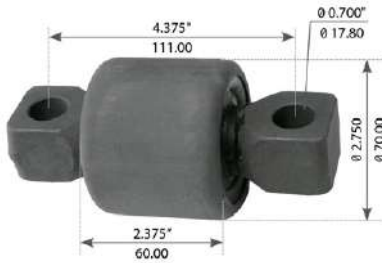

FortproUSA#: **F327354**

Replaces: 836940, 839310, 90008265

Notes: Kenworth Rear AG200/230/400/460 Airglide Suspension

## STABILIZER BUSH

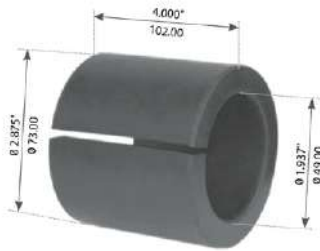

FortproUSA#: **F327329**

Replaces: K06650, K06658

Notes: Kenworth Rear AG100 Airglide Suspension

## TORQUE ROD BUSH



FortproUSA#: **F327355**

Notes: Kenworth AG 380 Series Suspension

## SPRING EYE BUSH

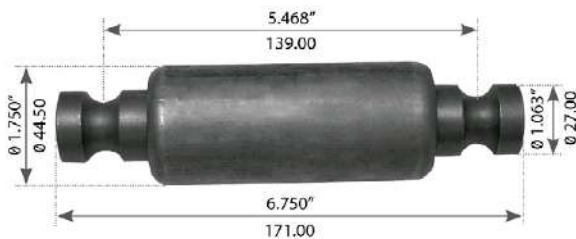

FortproUSA#: **F327357**

Replaces: B656005, RB328

Notes: Kenworth AG130 Air Suspension, C500B/550B, K100/300, T300/400/450/600/800/2000

## SPRING EYE BUSH



FortproUSA#: **F327358**

Replaces: 53231, B651001, RB249

Notes: Kenworth Front C500-550B, K100-300, T Series, W900N, L & S Suspension

# KENWORTH

## STABILIZER BUSHING

<b>FortproUSA#:</b> F327359
<b>Replaces:</b> K066450
<b>Notes:</b> Kenworth Rear AG200/230/400/460 Airglide Suspension

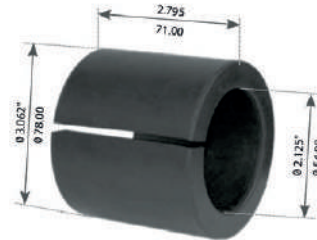

## STABILIZER BUSHING

<b>FortproUSA#:</b> F327360
<b>Replaces:</b> K066460
<b>Notes:</b> Kenworth Rear AG200/230/400/460 Airglide Suspension

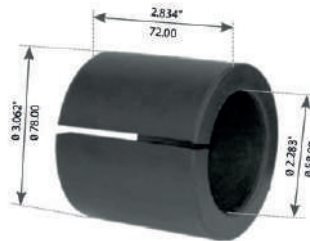

## WEAR PAD

<b>FortproUSA#:</b> F327328
<b>Replaces:</b> K174527
<b>Notes:</b> Kenworth Rear Glide Ride Tandem Suspension



## TRUNNION BUSHING

<b>FortproUSA#:</b> F327318
<b>Replaces:</b> K066232, K066350
<b>Notes:</b> Kenworth Rear Big 6 & KW6 4.0" Wide Suspension



## SPRING EYE BUSH

<b>FortproUSA#:</b> F327364
<b>Notes:</b> Kenworth Front C500B/550B, K100/300, T300/400/450/600/800/2000-W900B, L & S Suspension

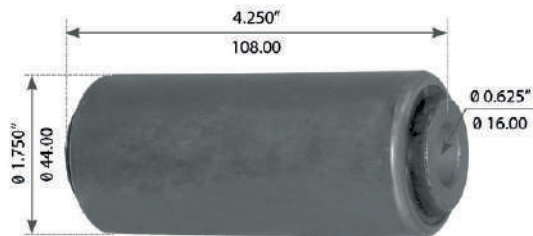



6300 NW 84 AVE  
MIAMI, FL 33166 - USA

## Heavy Duty Truck & Trailer Parts

# KENWORTH

### ■ SPRING EYE BUSH

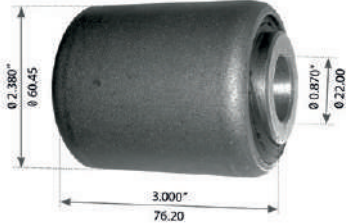

FortproUSA#: **F327365**

Replaces: C136002, RB292

Notes: Kenworth Rear AG380 Airslide Suspension

### ■ KIT, BAR PIN BUSHING



FortproUSA#: **F327317**

Replaces: 932420

Notes: E93240

### ■ TORQUE ARM BUSH



FortproUSA#: **F327319**

Replaces: K034-144

Notes: E4647

### ■ SPRING EYE BUSH



FortproUSA#: **F327323**

Replaces: E4644

### ■ BEAM BUSHING KIT



FortproUSA#: **F327330**

Replaces: K066-449



# KENWORTH

## TORQUE ROD WITH BUSHING

FortproUSA#: **F327339**

Replaces: TMR65B, 345-919, K195-474



## TORQUE ROD WITH BUSHING

FortproUSA#: **F327340**

Replaces: TMR67, 345-887, K195375, 17QF460P240, 25164946, 1661925C91, 62000-610, 6813262065

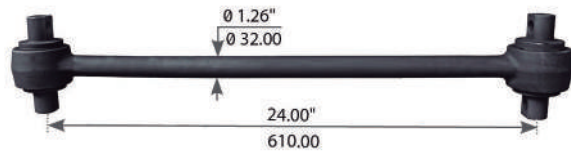

## TORQUE ROD WITH BUSHING

FortproUSA#: **F327341**

Replaces: TMR69, 345-885, K195-374



## TORQUE ROD WITH BUSHING

FortproUSA#: **F327342**

Replaces: TMR75, 345-886, 925150

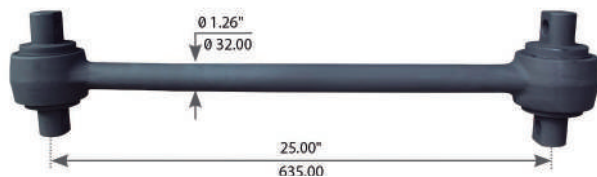



Heavy Duty Truck & Trailer Parts

**PETERBILT**

**CABIN MOUNT BUSH**



FortproUSA#: **F349540**

Replaces: 508968, M17804

Notes: Peterbilt Trucks

**CABIN MOUNT BUSH**

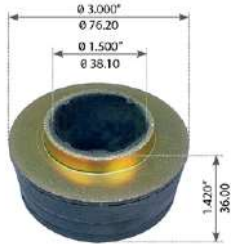

FortproUSA#: **F349541**

Replaces: 2008257, M20306

Notes: Peterbilt 357, 365, 378, 379, 385, 389 Series Trucks

**CABIN MOUNT BUSH**



FortproUSA#: **F349543**

Replaces: CB220370, M22370

Notes: Peterbilt Model 379, C15 & C11 Trucks

**TORQUE ARM BUSH**



FortproUSA#: **F184208**

Replaces: 47691000

Notes: Peterbilt Rear Flex Air Suspension

**TORQUE ARM BUSH**



FortproUSA#: **F174003**

Replaces: 44695000, 227720

Notes: Peterbilt Rear Air Trac Suspension





# PETERBILT

## TORQUE ROD BUSH

FortproUSA#: <b>F327354</b>
Replaces: 47691000
Notes: Peterbilt 4" Spring Tandem Suspension



## TORQUE ROD BUSH

FortproUSA#: <b>F327355</b>
Notes: Peterbilt Rear Flex Air Suspension



## TORQUE ARM BUSH

FortproUSA#: <b>F327364</b>
Notes: Peterbilt Front 4" COE & Conventional, 82 Present Suspension

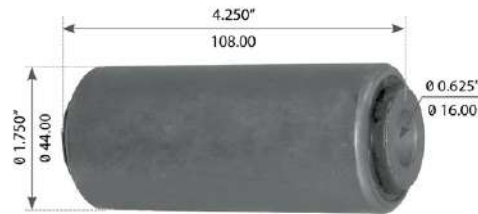

## TORQUE ARM BUSH

FortproUSA#: <b>F327365</b>
Replaces: C136002
Notes: Peterbilt Rear Flex Air Suspension



## REBUSHING KIT

FortproUSA#: <b>F349559</b>
Replaces: 03AL2
Notes: Peterbilt Rear Low Mount Air Leaf Suspension





6300 NW 84 AVE  
MIAMI, FL 33166 - USA

## Heavy Duty Truck & Trailer Parts

# PETERBILT

### BEAM END REBUSH KIT



FortproUSA#: **F349560**

Replaces: 03AL1

Notes: Peterbilt Air Leaf Suspension

### TORQUE ROD WITH BUSHING

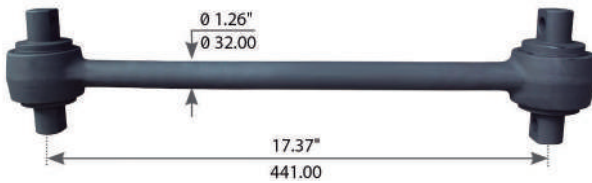

FortproUSA#: **F346926**

Replaces: TMR517, 345-196, 924170, 03-04119

### TORQUE ROD WITH BUSHING

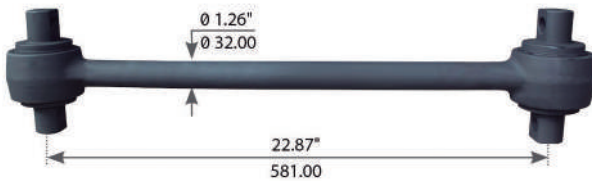

FortproUSA#: **F346927**

Replaces: TMR518, 345-210, 922820, 03-02439, 03-04059

### TORQUE ROD WITH BUSHING

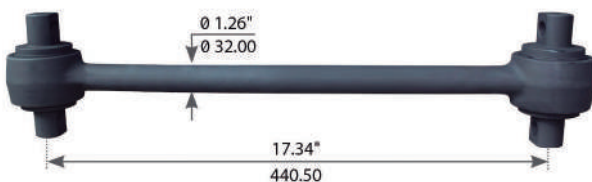

FortproUSA#: **F346929**

Replaces: TMR520, 345-211, 03-04327, 924175

138



Any reference to OEM names or OEM product identification numbers/descriptions/pictures/model numbers is for identification only and does not indicate that it is an OEM part. When ordering, customers have the option to order using industry references, OEM references or FortProUSA references.

# INTERNATIONAL

## CABIN MOUNT BUSH

<b>FortproUSA#:</b> F306926
<b>Replaces:</b> 503359C1, M203011
<b>Notes:</b> International Navistar CAB Over Trucks



## CABIN MOUNT

<b>FortproUSA#:</b> F306927
<b>Replaces:</b> 753997C93, M20305
<b>Notes:</b> International Navistar Trucks



## INSULATOR, CAB

<b>FortproUSA#:</b> F306928
<b>Replaces:</b> 3512104C2, 475941C2, M203059
<b>Notes:</b> International Navistar Rear 4000 Series Cabin Mount Code 16 CAC16030 & 16196 EXC4600 UH & For 7100 Series Model Truck

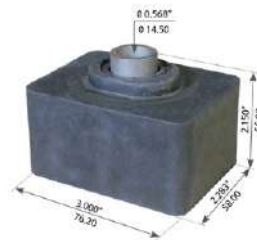

## INSULATOR CAB MOUNT

<b>FortproUSA#:</b> F306929
<b>Replaces:</b> 590981C1, M203067
<b>Notes:</b> International Navistar 16030 & 16196 Prior To 1994 Truck

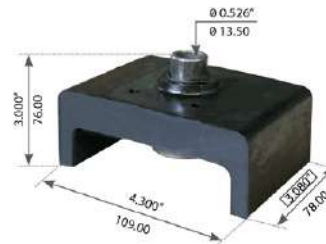

## INSULATOR CAB MOUNT

<b>FortproUSA#:</b> F306930
<b>Replaces:</b> 449713C2, M203069
<b>Notes:</b> International Navistar 7100 Trucks





Heavy Duty Truck & Trailer Parts

INTERNATIONAL

INSULATOR CAB MOUNT

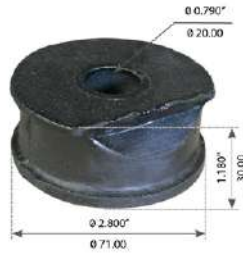

FortproUSA#: **F306931**

Replaces: 473987C3, M203079

Notes: International Navistar Trucks

INSULATOR CAB MOUNT

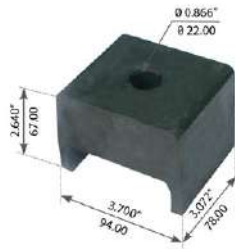

FortproUSA#: **F306932**

Replaces: 498396C1, M203065

Notes: International Navistar Trucks

INSULATOR CAB MOUNT

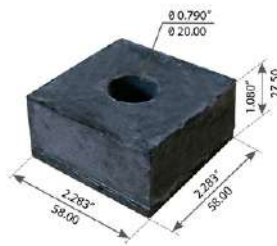

FortproUSA#: **F306933**

Replaces: 473935C1, M203063

Notes: International Navistar Rear 4000 Series  
Cabin Mount Code 16 CAC16030 & 16196  
EXC4600 UH & For 7100 Series Model Truck

CABIN MOUNT BUSH



FortproUSA#: **F306934**

Replaces: 3574680C1, M203073

Notes: International Navistar Truck

CABIN MOUNT BUSH



FortproUSA#: **F306935**

Replaces: 3595980C4

Notes: Navistar International DT466 Engine



# INTERNATIONAL

## MOTOR MOUNT

<b>FortproUSA#:</b> F306936
<b>Replaces:</b> 16647929C4, M17445
<b>Notes:</b> International Navistar 5000 Series N14 Trucks



## MOTOR MOUNT

<b>FortproUSA#:</b> F306920
<b>Replaces:</b> 503579C1, M20304
<b>Notes:</b> International Navistar



## MOTOR MOUNT, REAR

<b>FortproUSA#:</b> F306937
<b>Replaces:</b> 503837C1, 507659C91
<b>Notes:</b> International Navistar 25/2600, 81/82/8300, 91 - 9900 Trucks



## MOTOR MOUNT

<b>FortproUSA#:</b> F306938
<b>Replaces:</b> 1664728C1, M17437
<b>Notes:</b> International Navistar / IHC 6 CYL 360/408/466 Series Rear Suspension



## MOTOR MOUNT

<b>FortproUSA#:</b> F306939
<b>Replaces:</b> 1664723C3, M17450
<b>Notes:</b> International Navistar Trucks

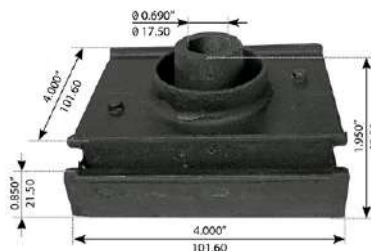



# INTERNATIONAL

## MOTOR MOUNT

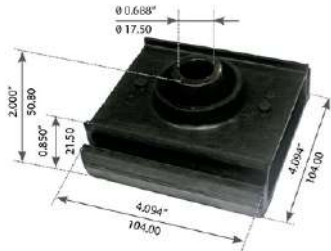

FortproUSA#: **F306940**

Replaces: 1664723C2, 1664723C3, 1664724C3, M17451

Notes: International Navistar Front Engine 3900 Model Trucks

## MOTOR MOUNT



FortproUSA#: **F306949**

Replaces: 1664730C5, 1664730C7, 2014777C2, M17447

Notes: International Navistar Paystar 530, 5000 Series N14 Series Engine

## MOTOR MOUNT

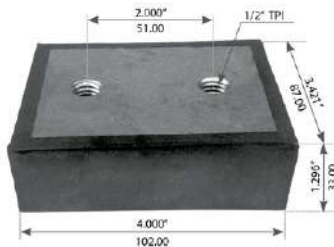

FortproUSA#: **F306950**

Replaces: M17329

Notes: International Navistar

## TORQUE ARM BUSH



FortproUSA#: **F184208**

Replaces: 47691000, 47691

Notes: International Navistar Rear Corporate 3 1/2" Single & Tandem Axles Suspension

## TORQUE ARM BUSH



FortproUSA#: **F174003**

Replaces: 227720

Notes: International Navistar Rear Corporate 3 1/2" Single & Tandem Axles Suspension





# Heavy Duty Truck & Trailer Parts

## INTERNATIONAL

### TORQUE ARM BUSH

<b>FortproUSA#:</b> F184248
<b>Replaces:</b> 1693069C1
<b>Notes:</b> International Navistar Special Tractors With 5TH Wheel Side Rail Suspension



### TORQUE ARM BUSH

<b>FortproUSA#:</b> F184211
<b>Replaces:</b> 322069C91
<b>Notes:</b> International Navistar



### TORQUE ROD BUSH

<b>FortproUSA#:</b> F174001
<b>Replaces:</b> 1693064C1
<b>Notes:</b> International Navistar



### WEAR PAD

<b>FortproUSA#:</b> F306967
<b>Replaces:</b> 571960C1
<b>Notes:</b> International Navistar Rear Corporate 3 1/2" Single & Tandem Axles Suspension



### EQUALIZER BUSH

<b>FortproUSA#:</b> F306921
<b>Replaces:</b> 497501C2
<b>Notes:</b> International Navistar 3 1/2" Single & Tandem Axle Suspension





# INTERNATIONAL

## SPRING EYE BUSH



FortproUSA#: **F306971**

Replaces: 3525665C1, RB253

Notes: International Navistar Front 32-3300; 41-4400  
4x2 3.0" WD. 73-7700, 85-8600 & 9900 &  
4.0" WD.W/ 3/4" RB'S, 02 & UP Suspension

## TORQUE ARM BUSH



FortproUSA#: **F306922**

Replaces: 497785C2

## TORQUE ROD WITH BUSHING

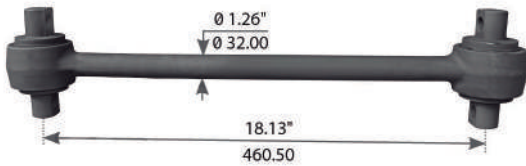

FortproUSA#: **F306910**

Replaces: TMR510, E-5282, 345-200, 493920C2

## TORQUE ROD WITH BUSHING



FortproUSA#: **F306913**

Replaces: TMR533, 345-904, 3548381C1,  
17QF358P8

## TORQUE ROD WITH BUSHING

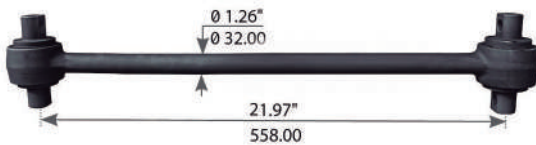

FortproUSA#: **F306923**

Replaces: TMR512, E-3789, 345-855, 493921C1

## CAB SHOCK ABSORBER AIR CAB SUPPORT



FortproUSA#: **F247945**

Replaces: 3595978C96, for International, Prostar,  
Lonestar (2007-2008)







## Heavy Duty Truck & Trailer Parts

# INTERNATIONAL

### TORQUE ARM BUSH

<b>FortproUSA#:</b> F306924
<b>Replaces:</b> 546036C1
<b>Notes:</b> 6-1/2" Long



### SPRING EYE BUSH

<b>FortproUSA#:</b> F306925
<b>Replaces:</b> 412587C1
<b>Notes:</b> 3" Long



# DETROIT

### OIL PAN GROMMET KIT

<b>FortproUSA#:</b> F051890
<b>Replaces:</b> DE23522281, M23771
<b>Notes:</b> Detroit 60 Series



### ISOLATOR ASSEMBLY

<b>FortproUSA#:</b> F051891
<b>Replaces:</b> 23530961
<b>Notes:</b> Detroit Diesel



### VALVE COVER GROMMET KIT

<b>FortproUSA#:</b> F051892
<b>Replaces:</b> 23522271, M23771
<b>Notes:</b> Detroit Diesel Series 60 Engine





## Heavy Duty Truck & Trailer Parts

# FORD

### MOTOR MOUNT



FortproUSA#: **F082490**

Replaces: BCD283172, F6H26068B, YC356068A  
M203028

Notes: Ford Lower & Rear Engine Mount 1999 &  
Later Applicable on Left & Right Ford Trucks

### MOTOR MOUNT



FortproUSA#: **F306920**

Replaces: DOHZ6068B, M20304

Notes: Ford F600, F700, F800 Series Suspension

### MOTOR MOUNT



FortproUSA#: **F082491**

Replaces: C8TZ6A061A, M203029

Notes: Ford Trucks





# Heavy Duty Truck & Trailer Parts

## MACK

### CABIN MOUNT

<b>FortproUSA#: F245621</b>
<b>Replaces:</b> 20QL250, M17529
<b>Notes:</b> Mack Upper CAB Application

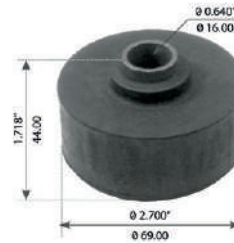

### INSULATOR

<b>FortproUSA#: F245620</b>
<b>Replaces:</b> 20QL1144
<b>Notes:</b> Metal Top



### CABIN MOUNT ASSEMBLY

<b>FortproUSA#: F245624</b>
<b>Replaces:</b> 30QS3373M, 30QS34279M, 30QS3479AM, M17530
<b>Notes:</b> Mack CH Series Trucks

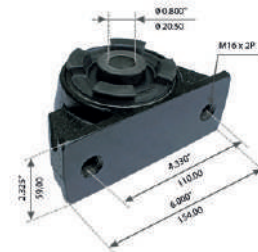

### INSULATOR

<b>FortproUSA#: F113101</b>
<b>Replaces:</b> 20QL324M, 20QL346M, M2
<b>Notes:</b> Mack Superliner Trucks

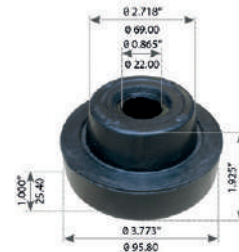

### INSULATOR

<b>FortproUSA#: F113100</b>
<b>Replaces:</b> 20QL1118A, 20QL1175, M1
<b>Notes:</b> Mack Rear Single Axle Suspension

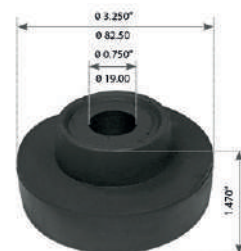



## Heavy Duty Truck & Trailer Parts

# MACK

### INSULATOR, TRANSMISSION KIT



FortproUSA#: **F113106**

Replaces: 204SX216

Notes: R / RD / CH Models

### WASHER D, TRANSMISSION



FortproUSA#: **F113107**

Replaces: 15QD1132

Notes: (D)

### SCREW, TRANSMISSION



FortproUSA#: **F113108**

Replaces: 1AX201

Notes: 3/4" X 6-1/4"

### NUT, FLANGED, LOCKING



FortproUSA#: **F113109**

Replaces: 191AM7

Notes: 3/4" - 16

### MOTOR MOUNT



FortproUSA#: **F245629**

Replaces: 20QL302P2, M5

Notes: Mack Trucks



# MACK

## CABIN MOUNT ASSEMBLY

FortproUSA#: <b>F010290</b>
Replaces: 20QL166, 20QL1171, M3
Notes: Mack QEB 1590 Trucks



## INSULATOR, FRONT MOTOR

FortproUSA#: <b>F010291</b>
Replaces: 20QL312M2
Notes: RD SERIES



## INSULATOR, FRONT MOTOR

FortproUSA#: <b>F010286</b>
Replaces: 20QL322
Notes: CH Model Lower



## INSULATOR, FRONT MOTOR

FortproUSA#: <b>F010287</b>
Replaces: 20QL329
Notes: CH Model Upper



## INSULATOR, ENGINE

FortproUSA#: <b>F245630</b>
Replaces: 20QL252P3





6300 NW 84 AVE  
MIAMI, FL 33166 - USA

## Heavy Duty Truck & Trailer Parts

# MACK

### INSULATOR, LOWER RADIATOR



FortproUSA#: **F245631**

Replaces: 20QL259A

### ROLLER, HOOD



FortproUSA#: **F245622**

Replaces: 55MX26

Notes: R Model

### SPRING INSULATOR



FortproUSA#: **F174037**

Replaces: 10QK332A

Notes: B, DM, F, MR, MC, Series

### INSULATOR, AIR DUCT



FortproUSA#: **F245632**

Replaces: 20QL29304

### MOTOR MOUNT

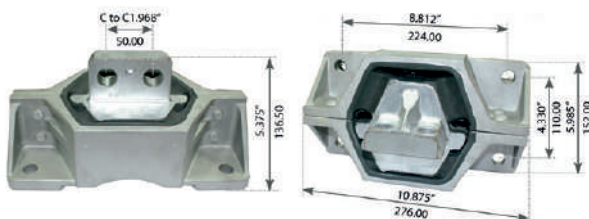

FortproUSA#: **F010288**

Replaces: 20QL47AM, 20QL47M, 25070943,  
YM53194211, M62247

Notes: Mack CH, CV, CL, CX Series Trucks

150



Any reference to OEM names or OEM product identification numbers/descriptions/pictures/model numbers is for identification only and does not indicate that it is an OEM part. When ordering, customers have the option to order using industry references, OEM references or FortProUSA references.

# Heavy Duty Truck & Trailer Parts

## MACK

### MOTOR MOUNT

<b>FortproUSA#:</b> F010289
<b>Replaces:</b> 20QL338M, M17528
<b>Notes:</b> Mack CH, RH & BR Series Trucks



### HOOD PIN

<b>FortproUSA#:</b> F245628
<b>Replaces:</b> 25QM31, M17429
<b>Notes:</b> Mack W900, T600, T800 Series Trucks

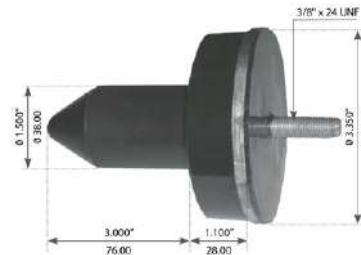

### HOOD HINGE BUSH

<b>FortproUSA#:</b> F245623
<b>Replaces:</b> 12QD1246M, 25154747, 4QM414AM, M24414
<b>Notes:</b> Mack W900, T600, T800 Series



### PIN, HOOD HINGE BUSH

<b>FortproUSA#:</b> F245618
<b>Replaces:</b> 12QD2146M, M24414
<b>Notes:</b> Mack W900, T600, T800 Series



### HOOD HINGE BUSH ASSEMBLY

<b>FortproUSA#:</b> F245619
<b>Replaces:</b> M24414
<b>Notes:</b> Mack CH Series Truck



# MACK

## HOOD BRACKET, LH



FortproUSA#: **F245638**

Replaces: 140QM434M, 20802371

Notes: Mack CH/CL Truck Series

## HOOD BRACKET, RH



FortproUSA#: **F245639**

Replaces: 140QM433M, 20802362

Notes: Mack CH/CL Truck Series

## SPRING EYE BUSH

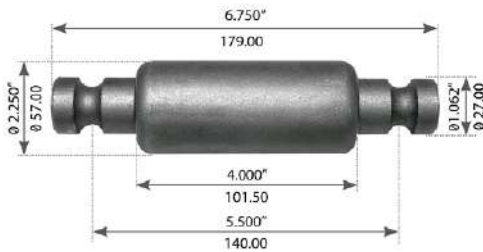

FortproUSA#: **F174082**

Replaces: 10QK3109, RB289

Notes: Mack Front CHN, CHU (Pinnacle) W/RB'S & CT, CTP, GU (Granite), TD (Titan) W/MTB'S 52 1/2" 04 10, CXN (Vision) 04 07, & CXP, CXU (Pinnacle) 07 10 Suspension

## TRUNNION BUSHING



FortproUSA#: **F174040**

Replaces: 10QK130P1

Notes: Mack Rear SS34-38 Camelback, W/Split Trunnion Suspension

## TORQUE ROD BUSH



FortproUSA#: **F174042**

Replaces: 46735

Notes: Mack Rear Maxair AL231 S/A, AL405 Tandem Suspension





## Heavy Duty Truck & Trailer Parts

# MACK

### INSULATOR, LOWER

<b>FortproUSA#:</b> F174030
<b>Replaces:</b> 10QK36B
<b>Notes:</b> 38,000-44,000 & 46,000 LBS



### INSULATOR, UPPER

<b>FortproUSA#:</b> F174031
<b>Replaces:</b> 10QK370
<b>Notes:</b> 44,000 LBS



### INSULATOR, UPPER

<b>FortproUSA#:</b> F174032
<b>Replaces:</b> 10QK365A
<b>Notes:</b> 38,000 & 46,000 LBS



### INSULATOR, LOWER

<b>FortproUSA#:</b> F174033
<b>Replaces:</b> 10QK372
<b>Notes:</b> 55,000 & 65,000 LBS



### INSULATOR, UPPER

<b>FortproUSA#:</b> F174034
<b>Replaces:</b> 10QK32BP1
<b>Notes:</b> 55,000 & 65,000 LBS





## Heavy Duty Truck & Trailer Parts

# MACK

### TORQUE RODS



FortproUSA#: **F296709**

Notes: 713-05 (Adjust)

### TORQUE RODS



FortproUSA#: **F296710**

Notes: 715-00 (Rigid)

### BRUSHING (BRONZE) 44,000 LBS



FortproUSA#: **F174050**

Replaces: 10QK157, 10QK255

Notes: 3.500" x 3.437"

### WASHER, THRUST (BRONZE)



FortproUSA#: **F174051**

Replaces: 43QK116A, 35AX688

Notes: I.D. 3.5000" O.D. 5.250"

### WASHER, TRUST (STEEL)



FortproUSA#: **F174052**

Replaces: 43QK117

Notes: I.D. 3.500" O.D. 5.375"





Heavy Duty Truck & Trailer Parts

**MACK**

**WASHER, LOCK**

<b>FortproUSA#:</b> F174053
<b>Replaces:</b> 23QJ112B
<b>Notes:</b> I.D. 3.312" O.D. 4.875"



**NUT, TRUNNION**

<b>FortproUSA#:</b> F174054
<b>Replaces:</b> 23QJ223



**TRUNNION ASSEMBLY 44,000 LBS**

<b>FortproUSA#:</b> F174004
<b>Replaces:</b> 39QK326, 39QK27E
<b>Notes:</b> 3-1/2" x 4"



**BRUSHING (BRONZE) 46,000 & 55,000 LBS**

<b>FortproUSA#:</b> F174060
<b>Replaces:</b> 10QK158A
<b>Notes:</b> 4.000" x 4.250"



**WASHER, TRUST (BRONZE)**

<b>FortproUSA#:</b> F174061
<b>Replaces:</b> 43QK115
<b>Notes:</b> I.D. 4.000" O.D. 6.187"





## Heavy Duty Truck & Trailer Parts

# MACK

### ■ WASHER, TRUST (STEEL)



FortproUSA#: **F174062**

Replaces: 43QK118

Notes: I.D. 4.000" O.D. 6.185"

### ■ TRUNNION ASSEMBLY 55,000 LBS



FortproUSA#: **F174005**

Replaces: 39QK24C, 39QK327

Notes: 4" x 5"

### ■ NUT, TRUNNION



FortproUSA#: **F174056**

Replaces: 25QJ220BP2

Notes: I.D. 3.875" O.D. 6.060"

### ■ CAP, TRUNNION (6 MOUNTING HOLES)



FortproUSA#: **F174057**

Replaces: 97QL3101

Notes: 8.500"

### ■ CAP, TRUNNION (6 MOUNTING HOLES)



FortproUSA#: **F174010**

Replaces: 97QL399P2



## Heavy Duty Truck & Trailer Parts

# MACK

### SPACER, U-BOLT

FortproUSA#: **F174009**

Replaces: 8QK335P2

Notes: 4" Width



### SPACER, INSULATOR

FortproUSA#: **F174008**

Replaces: 13QK246

Notes: 3" Width



### SHACKLE

FortproUSA#: **F174100**

Replaces: 22QK39301

Notes: 2" Width



### INSULATOR BOX

FortproUSA#: **F174038**

Replaces: 52QK418BP4

Notes: 4" Spring



### SEAL TRUNNION

FortproUSA#: **F174055**

Replaces: 88AX449

Notes: 44,000 Lbs



# MACK

## SEAL TRUNNION



FortproUSA#: **F174065**

Replaces: 88AX253

Notes: 55,000 Lbs

## BUSHING



FortproUSA#: **F174041**

Replaces: 10QK130P1

Notes: Polyurethane

## INSULATOR, LOWER



FortproUSA#: **F174030P**

Replaces: 10QK388

Notes: Polyurethane

## INSULATOR, LOWER



FortproUSA#: **F174033P**

Replaces: 10QK389

Notes: Polyurethane

## TAPERED STUD CARTRIDGE



FortproUSA#: **F174001**

Replaces: 1688-229240

Notes: 46735



## Heavy Duty Truck & Trailer Parts

# MACK

### STRADDLE MOUNT 2-1/2" CARTRIDGE

FortproUSA#: **F174002**

Replaces: 1688-227710

Notes: 44694

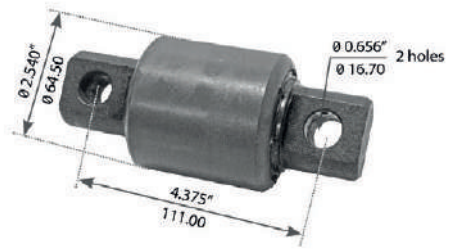

### STRADDLE MOUNT 2-3/4" CARTRIDGE

FortproUSA#: **F174003**

Replaces: 1688-227720

Notes: 44695

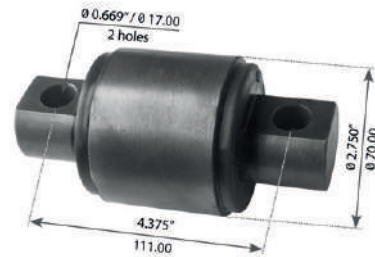

# VOLVO

### CABIN MOUNT BUSH

FortproUSA#: **F339420**

Replaces: 8074666, M203054

Notes: Volvo VBN, VN Series Trucks

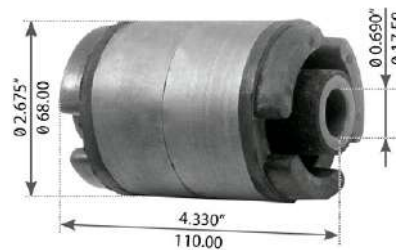

### ENGINE MOUNTING

FortproUSA#: **F339421**

Replaces: 20723224, 21228153

Notes: Volvo FH & FM Series Trucks

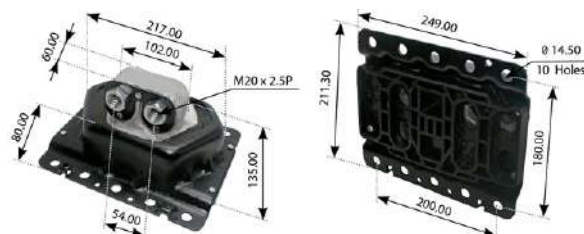



6300 NW 84 AVE  
MIAMI, FL 33166 - USA

## Heavy Duty Truck & Trailer Parts

# VOLVO

### ENGINE MOUNTING



FortproUSA#: **F339422**

Replaces: 1629614, 3198122

Notes: Volvo FH12, FH16, NH12 Series Trucks

### ENGINE MOUNTING



FortproUSA#: **F339423**

Replaces: 1503283, 1573891

Notes: Volvo F10, F12, N10, N12, NL10, NL12 Series Trucks

### MOTOR MOUNT



FortproUSA#: **F339424**

Replaces: 8077380

Notes: Volvo WG64, VN, VNL, Series Suspensions

### MOTOR MOUNT

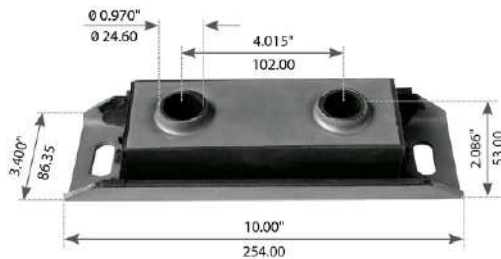

FortproUSA#: **F339425**

Replaces: 120053207, M203048

Notes: Volvo / GMC Heavy Duty Trucks

### MOTOR MOUNT



FortproUSA#: **F339426**

Replaces: 120053208, M203049

Notes: Volvo GMC Trucks

160



Any reference to OEM names or OEM product identification numbers/descriptions/pictures/model numbers is for identification only and does not indicate that it is an OEM part. When ordering, customers have the option to order using industry references, OEM references or FortProUSA references.





## Heavy Duty Truck & Trailer Parts

# VOLVO

### RADIATOR MOUNT

FortproUSA#: **F339427**

Replaces: 0324842, 6850149, 70305823

Notes: Volvo B7, B10, B12, FH16, FL6, N10, N12 Series Trucks & Bus

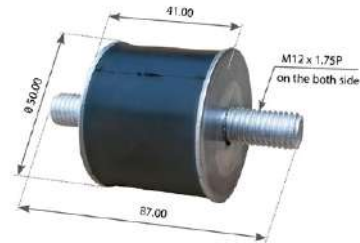

### INSULATOR PAD

FortproUSA#: **F339462**

Replaces: 20568741, 8079889, 8081145

Notes: Volvo/White Rear 4" Spring Tandem Suspension



### TORQUE ROD WITH BUSHING

FortproUSA#: **F339440**

Replaces: TMR63, 095.421, 345-898, 20396154

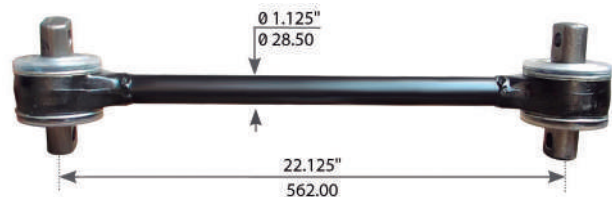



6300 NW 84 AVE  
MIAMI, FL 33166 - USA

## Heavy Duty Truck & Trailer Parts

# HUTCH

### EQUALIZER



FortproUSA#: **F296701**

Replaces: 750-03

### FRONT HANGER (UNDERMOUNT)



FortproUSA#: **F296702**

Replaces: 7701-02

### CENTER HANGER (UNDERMOUNT)



FortproUSA#: **F296703**

Replaces: 7702-02

### REAR HANGER (UNDERMOUNT)



FortproUSA#: **F296704**

Replaces: 7703-02

### EQUALIZER BUSHING



FortproUSA#: **F296707**

Replaces: 7010-00

162



Any reference to OEM names or OEM product identification numbers/descriptions/pictures/model numbers is for identification only and does not indicate that it is an OEM part. When ordering, customers have the option to order using industry references, OEM references or FortProUSA references.



# HUTCH

## EQUALIZER BOLT ASSEMBLY

FortproUSA#: **F296706**

Replaces: 10287-01



## TORQUE ARM BUSHING

FortproUSA#: **F296708**

Replaces: 722-00



## TORQUE ARM BOLT

FortproUSA#: **F296713**

Replaces: 719-02

Notes: 5" X 1" - 14



## TORQUE ARM NUT

FortproUSA#: **F296714**

Replaces: 10562-00

Notes: 1" -14 TPI



## TORQUE RODS

FortproUSA#: **F296709**

Notes: 713-05 (Adjust)





## Heavy Duty Truck & Trailer Parts

# HUTCH

### TORQUE RODS



FortproUSA#: **F296710**

Notes: 715-00 (Rigid)

### CENTER HANGER



FortproUSA#: **F296719**

Replaces: 16171-01

Notes: H9700

### AXLE SEAT



FortproUSA#: **F296711**

Replaces: 705-01

### TOP PLATE



FortproUSA#: **F296705**

Replaces: 7029-00

### EQUALIZER



FortproUSA#: **F296715**

Replaces: 16158-01





## HUTCH

### EQUALIZER BUSHING

FortproUSA#: **F296716**

Replaces: 16146-01



### EQUALIZER BOLT KIT

FortproUSA#: **F296712**

Replaces: 16353-01



### EQUALIZER BUSHING ASSY

FortproUSA#: **F296717**

Replaces: E9472



### EQUALIZER BUSHING ASSY

FortproUSA#: **F296718**

Replaces: E2003





# REYCO

## EQUALIZER BUSHING



FortproUSA#: **F214501**

Replaces: T5524

## TORQUE ARM BUSHING



FortproUSA#: **F214502**

Replaces: T5493

## EQUALIZER



FortproUSA#: **F214503**

Replaces: T5427

## EQUALIZER BUSHING ASSY



FortproUSA#: **F214525**

Replaces: TK18998

Notes: E3976

## TORQUE ARM BUSHING KIT



FortproUSA#: **F214526**

Replaces: TK19089

Notes: E1983



## REYCO

### ADJUSTABLE TORQUE ROD ADJUSTABLE TORQUE ROD

FortproUSA#: **F214515**

Replaces: T5485

Notes: 15-1/2" - 17-1/2"



### RIGID TORQUE ROD

FortproUSA#: **F214520**

Replaces: T7635

Notes: 16-1/4" Length



### EQUALIZER SHAFT

FortproUSA#: **F214527**

Replaces: T5888, 1424701

Notes: 3/8" Length



### EQUALIZER WASHER

FortproUSA#: **F214528**

Replaces: T5887, 142901

Notes: I.D. 13/16" O.D. 3-3/4"



### EQUALIZER LOCK WASHER

FortproUSA#: **F214529**

Replaces: T3164, 142501

Notes: I.D. 13/16"





# REYCO

## EQUALIZER LOCK SCREW



FortproUSA#: **F214530**

Replaces: T5886, 1424801

Notes: 2-1/2" Length

## TORQUE ARM BOLT



FortproUSA#: **F214531**

Replaces: T5492

Notes: 1" - 4 x 7" Long

## TORQUE ARM WASHER



FortproUSA#: **F214532**

Replaces: T2224

Notes: I.D. 1-1/16" O.D. 2-3/4"

## TORQUE ARM LOCK NUT



FortproUSA#: **F214533**

Replaces: T5495

Notes: 1" - 14"







Heavy Duty Truck & Trailer Parts

# TORQUE RODS



FortProUSA#	Type	Brand	Replaces	Length	Bush Angle	Bush 1	Bush 2	Bare Rod
<b>F327340</b>	1	Kenworth	K195375, 944270, TMR67	24.000"	0° & 0°	10.060	10.060	120.026
<b>F327341</b>	2	Kenworth	K195376, 925031, TMR69	24.000"	0° & 15°	10.060	10.061	120.026
<b>F327342</b>	1	Kenworth	925150, TMR75	25.000"	0° & 0°	10.069	10.069	120.030
<b>F306910</b>	1	International, Navistar	493920C1, TMR510	18.125"	0° & 15°	10.060	10.060	120.007
<b>F346926</b>	1	Peterbilt	0304119, 924170, TMR517	17.373"	0° & 15°	10.060	10.060	-
<b>F346927</b>	1	Peterbilt	0302439, TMR518	22.875"	0° & 0°	10.060	10.060	120.024
<b>F346929</b>	1	Peterbilt	0304327, 924175, TMR520	17.343"	10° & 0°	10.060	10.097	120.005
<b>F317226</b>	1	Freightliner	1610420001, IPC927180, TMR513	18.187"	90° & 45°	10.055	10.055	-
<b>F317225</b>	1	Freightliner	6813266716, 1616749001, TMR514	24.000"	90° & 45°	10.055	10.055	-
<b>F317230</b>	1	Freightliner	6813266316, 1616749000, TMR515	23.000"	90° & 35°	10.055	10.055	-
<b>F317227</b>	1	Freightliner	1613053000, TMR516	16.625"	90° & 90°	10.055	10.055	-
<b>F306923</b>	1	International, Navistar	493921C1, TMR512	21.696"	15° & 15°	10.055	10.055	-
<b>F317210</b>	1	Freightliner	1616749002, TMR535	24.5"	90° & 35°	10.084	10.084	-
<b>F327339</b>	1	Kenworth	K195-474, TMR65B	19.75"	0° & 0°	540.027	540.027	-
<b>F339440</b>	1	Volvo	20396154, TMR63	22.125"	0° & 0°	-	-	-
<b>F346930</b>	1	Peterbilt, Neway	0305108, 5550343, R307853, TMR532	25.78"	0° & 0°	-	-	-
<b>F306913</b>	1	International, Hendrickson	3548381C1, 17QF358P8, TMR533	25.375"	0° & 0°	-	-	-





## WATER PUMPS



Item No.	Item Description	Replaces	Application
<b>F010038</b>	WATER PUMP ASSY (LONG SHAFT) (E6)	316GC1211A	Mack
<b>F010039</b>	WATER PUMP ASSY (E7)	316GC284A	Mack
<b>F010040</b>	WATER PUMP ASSY (E7) (E-TECH)	316GC285B	Mack
<b>F010041</b>	WATER PUMP ASSY MP7 / MP8 (Aluminum Impeller)	85124623 / 85142305	Mack
<b>F010041E</b>	WATER PUMP ASSY MP7 / MP8	85124623 / 85142305	Mack
<b>F020467</b>	WATER PUMP ASSY (855) WITH IDLER - SMALL CAM - FFC	3801715	Cummins
<b>F020468</b>	WATER PUMP ASSY (855) (BC I, II)	3801788	Cummins
<b>F020469</b>	WATER PUMP ASSY (855) (BCI,II,III,IV)	3801708	Cummins
<b>F020470</b>	WATER PUMP ASSY (855) (BCIV) With Idler - 88NT	3803138	Cummins
<b>F020664</b>	WATER PUMP ASSY 4-6 BT	3802970	Cummins
<b>F020844</b>	WATER PUMP ASSY 6CT	3802081	Cummins
<b>F020938</b>	WATER PUMP ASSY N14	3803605	Cummins
<b>F021045</b>	WATER PUMP ASSY L10, M11, ISM	3803403	Cummins
<b>F031384</b>	WATER PUMP ASSY 3116, 3126	4P3683	CAT
<b>F051856</b>	WATER PUMP ASSY S60	23526039	Detroit
<b>F051857</b>	WATER PUMP ASSY S60 (12.7L & 14L EGR)	23535017	Detroit



# MISCELLANEOUS COMPONENTS

## RADIATOR ACCESSORIES



1



2



3

Key	FortProUSA#	References	Description
1	F286301	16MF250	Radiator Cap 2 5/8" Neck
2	F286303	16MF264	Radiator Cap 2 1/4" Neck
3	F010044	11MF3373	Tube Steel Lower Radiator 2 1/2"

## FANS

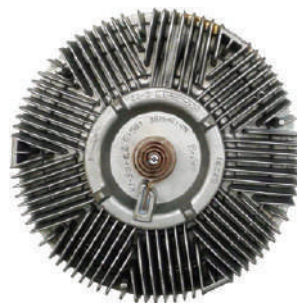

FortProUSA#	References	Description	Hub Dia	Pilot Dia	Length	Fan Dia	Notes
F247995	38MH414M	Fan Clutch	2.56"	5"	4.19"	26"	Mack E7
F247996	38MH416P2, 9902002	Fan Clutch	2.56"	5"	3.48"	26"	Mack E6
F247997	40MH48, 991451	Fan Clutch	2.56"	5"	4.74"	26"	Mack E7
F247998	40MH51	Fan Clutch	2.56"	2.56"		26"	Mack E - Tech
F247999	38MH423AM	Fan Clutch	2.56"	5"	3.48"	26"	Mack E - Tech





## MISCELLANEOUS COMPONENTS

### FANS



FortProUSA#	References	Description	Blades	Material	Pilot Dia	Fan Dia	Notes
<b>F247984</b>	2MH414P64	FAN	6	Fiberglass	2"	24"	R, RD Models
<b>F247985</b>	2MH429, 916535	FAN	8	Aluminun	5"	24"	CH, RD Models
<b>F247986</b>	2MH364	FAN	8	Fiberglass	5"	26"	Vision
<b>F247987</b>	2MH460	FAN	9	Fiberglass	2,56"	24"	
<b>F247988</b>	2MH360M, 917239	FAN	7	Fiberglass	5"	24"	
<b>F247989</b>	4735-38449-17	FAN	10	Nylon	3.25"	20"	4BT
<b>F247990</b>	4735-40518-05	FAN	9	Nylon	5"	26"	6BT
<b>F247991</b>	4735-42111-02	FAN	9	Nylon	2"	30"	
<b>F247992</b>	4735-41391-02	FAN	9	Nylon	2"	30"	Kenwoth
<b>F247993</b>	4735-42904-08	FAN	8	Nylon	2.56"	30"	
<b>F247994</b>	4735-41392-01	FAN	9	Nylon	2.56"	30"	FL CL120, ISX
<b>F248020</b>	2005452C1	FAN	9	Nylon	2.56"	30"	
<b>F248021</b>	2010884C1	FAN	9	Nylon	2"	30"	
<b>F248022</b>	2000729C2	FAN	9	Nylon	5"	30"	
<b>F248023</b>	3507486C1	FAN	9	Nylon	2.56"	31"	
<b>F248024</b>	3507485C1	FAN	9	Nylon	5"	31"	
<b>F248025</b>	481976C1	FAN	9	Nylon	2"	28"	



## MISCELLANEOUS COMPONENTS

### COOLING COMPONENTS

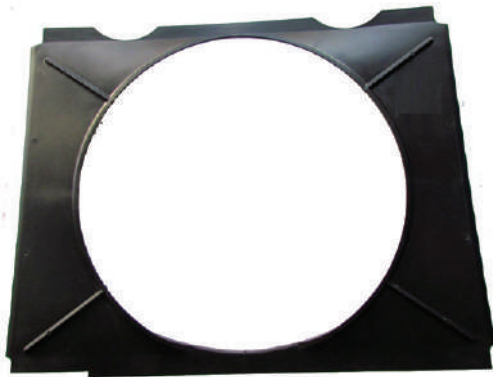

1

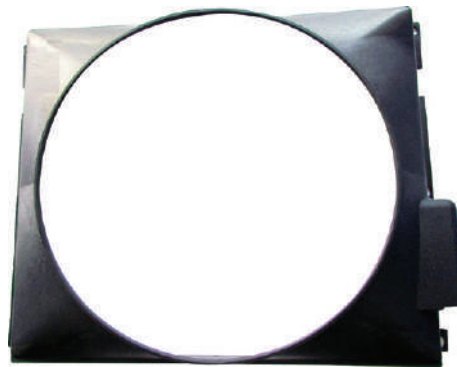

2

Key	FortProUSA#	References	Description
1	<b>F245636</b>	5MH4373	Shroud Fan R / RD Models
2	<b>F245637</b>	5MH5173	Shroud Fan RD Models



1



2



3



4



5

Key	FortProUSA#	References	Description
1	<b>F245552</b>	76MF520M	Cooland Tank Surge
2	<b>F245553</b>	76MF516M	Cooland Tank Recovery
3	<b>F286303</b>	16MF264	Surge Tank Cap
4	<b>F246309</b>	3150-063415	Recovery Tank Cap
5	<b>F246310</b>	16MF265AM	Surge Tank Cap

## MISCELLANEOUS COMPONENTS

### COOLANT TANKS



1



2



3

Key	FortProUSA#	References	Description
1	F247861	05-23045-000, 05-20529-000	Coolant Reservoir for Freightliner Century & Columbia Application
2	F247862	05-23195-000	Coolant Tank for Freightliner M2 Application
3	F247863	2002105C3	Coolant Tank for International 4000 Series

### MISCELLANEOUS COMPONENTS



1



2



3



4



5



6



7



8

Key	FortProUSA#	References	Description
1	F010244	477GB3121B	Tube, Oil Filler
2	F010245	477GB471	Tube, Oil Filler (Steel)
3	F010247	222GB27A	Cap Oil 2" (Bottle Stopper Type)
4	F010248	222GB213	Cap Oil 1 3/8"
5	F010249	7649-AAX1193	Cap Oil 2"
6	F255740	9424-254387S	Dips Tick, Power Steeling
7	F112808	4304602	Breather, Transmission
8	F143420	541KB29	Breather



## MISCELLANEOUS COMPONENTS

### PRIMER PUMP

FortproUSA#: **F010266**

Replaces: 318GC17A

Notes: E6



## CLUTCH COMPONENTS

### BRAKE, CLUTCH DISC

FortproUSA#: **F275960**

Replaces: 127760



### Frition Disc T2080, T2080B, T2090, T2100, T2110B, T2130T, T2180

FortproUSA#: **F102720**

Replaces: 495KB361, GSD2525

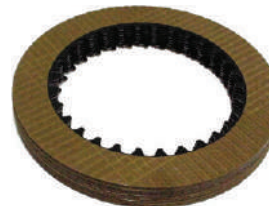

### Reaction Disc T2080, T2080B, T2090, T2100, T2110B, T2130T, T2180

FortproUSA#: **F102721**

Replaces: 495KB367, GSD2526





Heavy Duty Truck & Trailer Parts

# CLUTCH COMPONENTS

## CLUTCH KITS 15-1 / 2"X 2" - 10 SPLINES

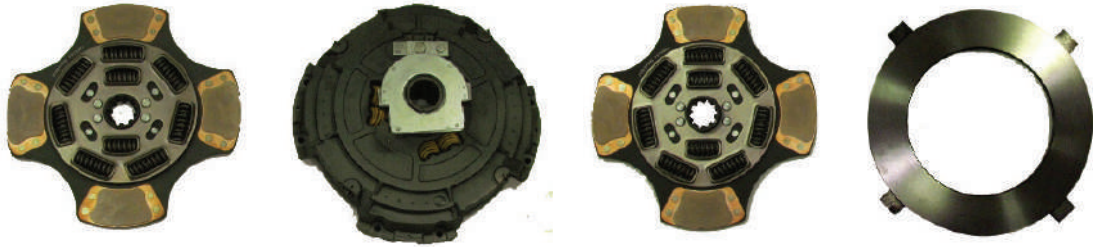

\* Mack Only

FortProUSA#	Replaces	Load (Lbs)	Spring QTY	Facing	Torque Rating (LB/FT)	Flywheel Minimum Opening
F276013	108391-74B	3,600	10	4 Pad	1,650	8.5"
F276014*	108935-51	3,600	9	4 Pad	1,650	10"
F276015	108925-82	3,600	7	4 Pad	1,700	10"
F276016*	108935-94	4,000	9	6 Pad	1,750	10"
	108935-91					
F276017	108925-25	4,000	6	6 Pad	2,050	10"
	108935-20					
	108935-15					

## CLUTCH KITS 14"X 2" - 10 SPLINES

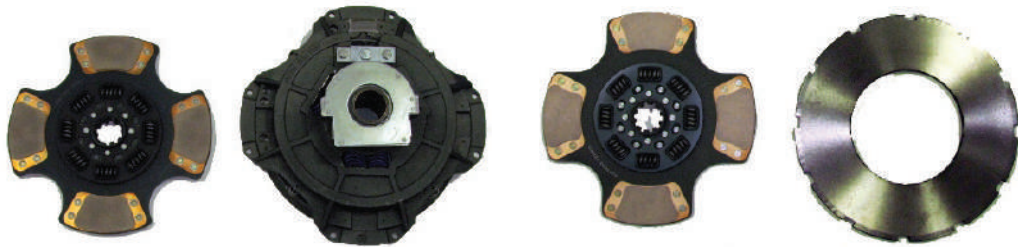

FortProUSA#	Replaces	Load (Lbs)	Spring QTY	Facing	Torque Rating (LB/FT)	Flywheel Minimum Opening
F276008	108034-82	3,600	8	Organic	1,150	7"
	108034-57					
F276009	108034-61	3,600	8	3 Pad	1,250	7"
F276010	108050-59	3,600	8	4 Pad	1,400	7"
	108950-59					







Heavy Duty Truck & Trailer Parts

# CLUTCH COMPONENTS

## CLUTCH KITS 14"X 1-3/4" - 10 SPLINES

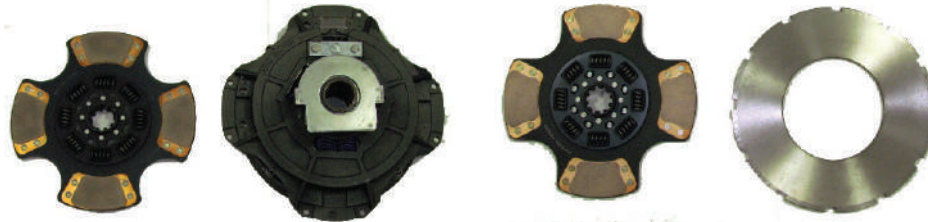

FortProUSA#	Replaces	Load (Lbs)	Spring QTY	Facing	Torque Rating (LB/FT)	Flywheel Minimum Opening
F276004	107137-8	2,800	8	6 Pad	900	7" (Stamped)
F276006	107035-59	3,600	8	4 Pad	1,250	7"
F276007	107237-10	2,000	8	3V Pad	860	7" (Stamped)
F276005	107213-7	2,400	8	4 Pad	560	7" - 1 Disc

## CLUTCH DISCS

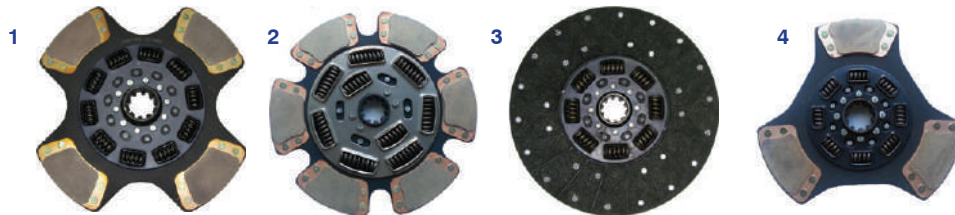

Key	FortProUSA#	Replaces	Disc Dia.	Spline	Hub Type	Facing	Pads	Position
1	F275989	128257	15-1/2"	2" x 10"	10 Spring	Ceramic	4	Front 8.5"
1	F275990	128258	15-1/2"	2" x 10"	10 Spring	Ceramic	4	Rear 8.5"
1	F275993	128362	15-1/2"	2" x 10"	9 Spring	Ceramic	4	Front 10"
1	F275994	128363	15-1/2"	2" x 10"	9 Spring	Ceramic	4	Rear 10"
1	F275995	128462	15-1/2"	2" x 10"	7 Spring	Ceramic	4	Front/Rear 10"
2	F275996	128570	15-1/2"	2" x 10"	9 Spring	Ceramic	6	Front 10"
2	F275997	128571	15-1/2"	2" x 10"	9 Spring	Ceramic	6	Rear 10"
2	F275998	128604	15-1/2"	2" x 10"	6 Spring	Ceramic	6	Front/Rear 10"
3	F275977	128314	14"	2" x 10"	8 Spring	Organic		Front 7"
3	F275978	128315	14"	2" x 10"	8 Spring	Organic		Rear 7"
4	F275979	128442	14"	2" x 10"	8 Spring	Ceramic	3	Front 7"
4	F275980	128443	14"	2" x 10"	8 Spring	Ceramic	3	Rear 7"
1	F275971	128229	14"	2" x 10"	8 Spring	Ceramic	4	Front 7"
1	F275972	128230	14"	2" x 10"	8 Spring	Ceramic	4	Rear 7"
1	F275961	128281	14"	1-3/4" x 10"	8 Spring	Ceramic	4	Front 7"
1	F275962	128282	14"	1-3/4" x 10"	8 Spring	Ceramic	4	Rear 7"





## CONTROL CABLES

### ENGINE STOP CABLE



FortProUSA#	Description	Replaces
F245610-076	Engine Stop Cable (76in)	21QB3249RP76
F245610-078	Engine Stop Cable (78in)	21QB3249RP78
F245610-100	Engine Stop Cable (100in)	21QB3249RP100
F245610-108	Engine Stop Cable (108in)	21QB3249RP108
F245610-112	Engine Stop Cable (112in)	21QB3249RP112

### CLUTCH RELEASE CABLE



FortProUSA#	Description	Replaces
F245640-066	Clutch Release (66 in) (R & DM Models)	27RC333BP3
F245640-096	Clutch Release (96 in) (DM Models)	27RC333BP9
F245640-102	Clutch Release (102 in) (MR & MC Models)	27RC333BP5

### TACHOMETER & SPEEDOMETER CABLE



FortProUSA#	Description	Replaces
F245650-088	Tachometer & Speedometer Cable (88 in)	54MT313BP88
F245650-112	Tachometer & Speedometer Cable (112 in)	54MT313P112

### CLUTCH CABLE



<b>FortproUSA#:</b> F245643
<b>Replaces:</b> 27RC410M, 21088848, 22175475
<b>Notes:</b> Mack Granite, Vision





HOME ABOUT US OUR PRODUCTS CATALOGS LOCATIONS BLOG CONTACT US CUSTOMER PORTAL

Experience the  
quality  
parts

77  
FORTPRO is a leader in the research  
and distribution of a broad range  
of truck parts such as air  
electrical, driveline, suspension



EXPANDING

Products in

Looking for more parts?  
We have more catalogs available online  
Please visit us at  
[www.fortpro.com/catalogs](http://www.fortpro.com/catalogs)



6300 NW 84 AVE  
Miami, FL 33166 - USA  
Phone: 305-392.9974  
Fax: 305-392.9975

[info@fortpro.com](mailto:info@fortpro.com)  
[www.fortpro.com](http://www.fortpro.com)